

**February 2018**

**Edition 7.3**



# **BEHAVIORAL HEALTH DESIGN GUIDE**

Formerly:

Design Guide for the Built Environment  
of Behavioral Health Facilities

**James M. Hunt, AIA**

**David M. Sine, DrBE, CSP, ARM, CPHRM**

***Includes REVISED  
Patient Safety Risk Assessment Tool  
to align with The Joint Commission's  
November 2017 Recommendations***

**Behavioral Health Facility Consulting, LC**

Previously Published by:

National Association of Psychiatric Health Systems (NAPHS) 2003-2014  
Facility Guidelines Institute (FGI) 2015-2017

The hospital plans activities to minimize risks in the environment of care.

Risks are inherent in the environment because of the types of care provided and the equipment and materials needed to provide that care. The best way to manage these risks is through a systematic approach that involves proactive evaluation of the harm that could occur. By identifying one or more individuals to coordinate and manage risk assessment and reduction activities—and to intervene when conditions immediately threaten life and health—organizations can be more confident that they have minimized the potential for harm.

The hospital manages safety and security risks.

Beginning in March 2017, the Joint Commission is emphasizing assessment of ligature, suicide, and self-harm observations in psychiatric hospitals and inpatient psychiatric patient areas in general hospitals. A March 1, 2017, [Joint Commission Online article](#) details specific steps surveyors will take during on-site surveys to document all observations of ligature or self-harm risks in the environment. Each observation of a ligature or self-harm risk will be considered a requirement for improvement (RFI).

***Joint Commission Online***

**March 1, 2017**

“Listen to the patients; they’ll tell you what you need to know.”

**J.J., Safety Officer**

**Greystone Park State Psychiatric Hospital**

**New Jersey**

# Behavioral Health Design Guide

**Edition 7.3**

**February 2018**

© 2018 Behavioral Health Facility Consulting, LLC

In an effort to keep up with the rapid increase in the number of products available for use in behavioral health facilities, this document will be updated frequently. The date of each edition is on the cover and at the bottom of each page of the document.

Readers are urged to check: [www.bhfcllc.com](http://www.bhfcllc.com)

whenever referring to this document to assure the latest information is being accessed.

## **EDITION 7.3**

This edition has been heavily revised and edited since the last edition. Therefore, text that has been revised since the last edition is not shown in blue, as has been our practice in the past.

# CONTENTS

Introduction .....	5
A Word from the Authors .....	6
Share Your Bright Ideas.....	7
Acknowledgments .....	7
A Word from BHFC.....	8
General Comments	
1. Space Planning Considerations .....	9
2. Safety.....	11
3. Outdoor Areas.....	14
Construction and Materials Considerations	
Level I. Staff and Service Areas .....	16
Level II. Corridors, Counseling Rooms, and Interview Rooms .....	16
Level III. Lounges and Activity Rooms .....	27
Level IV-a. Patient Rooms.....	29
Level IV-b. Patient Toilets .....	37
Level V-a. Admissions.....	45
Level V-b. Seclusion Rooms .....	46
Summary .....	48
Appendix.....	49
About the Authors .....	109
Definitions/Resources .....	110
List of Manufacturers .....	111

## INTRODUCTION

This document is intended to address the built environment of the general adult inpatient behavioral health care unit. Additional considerations that are *not* addressed here are required for child and adolescent patients, patients with medical care needs, dementia patients, and some patients with diagnoses such as substance abuse and eating disorders.

This document is not a replacement for regulatory requirements, but rather augments them to detail practical means of protecting patients and staff. It is intended to represent best current practices, in the opinion of the authors. It is not intended to represent minimum acceptable conditions and should not be interpreted as establishing a legal “standard of care” that facilities are required to follow.

***PLEASE NOTE:***

Product information included in this document is intended for illustration of one or more specific items that are deemed appropriate for use in this type of facility. Comparable products by other manufacturers that meet the same design criteria may be substituted after careful comparison.

## A WORD FROM THE AUTHORS

The *Design Guide* continues to be based on our experiences in the field as operators, designers, consultants, and surveyors. Our goal is to share what we have seen that is working and what we have seen that has not worked. Since the document was first electronically published by the National Association of Psychiatric Health Systems (NAPHS) in 2003, we have received and welcomed countless suggestions, recommendations, and comments from users of the *Design Guide*, which continue to inform and lead us to new discoveries. We are grateful and humbled by how well our suggestions have been received and that they have inspired others to think of new solutions to the inherent challenges of the behavioral health, built environment.

We hope this edition of the *Behavioral Health Design Guide* (formerly the *Design Guide for the Built Environment of Behavioral Health Facilities*) will meet the expectations of and prove useful to the designers, operators, and clinicians who are entrusted with both the care of behavioral health patients and with the environment of care in which those people are cared for and treated.

As always, we introduce this edition with the same reminder we used to introduce the inaugural edition in 2003: “While a safe environment is critical, no environment of care can be totally safe and free of risk. No built environment—no matter how well designed and constructed—can be relied upon as an absolute preventive measure. Staff awareness of their environment, the latent risks of that environment, and the behavioral characteristics and needs of the patients served in that environment are absolute necessities. We also know that different organizations and different patient populations will require greater or lesser tolerance for risk; an environment for one patient population will not be appropriate for another. Each organization should continually visit and revisit their tolerance for risk and changes in the dynamics of the patient population served.”

As in earlier editions, we have highlighted products we have found to be both safe and able to withstand the rigors of use in the behavioral health care environment. However, inclusion or exclusion of a product does not indicate endorsement or disapproval of that product, nor does it suggest that any product we identify is free of risk. As well, there may be equivalent products available; all facilities should continually look to the marketplace to find products that are safer and more cost-effective.

**James M. Hunt, AIA, NCARB**  
President  
Behavioral Health Facility Consulting,  
LLC.  
2342 SE Alamar Road  
Topeka, KS 66605  
[jim@bhfc.com](mailto:jim@bhfc.com)  
[www.bhfc.com](http://www.bhfc.com)

**David M. Sine, DrBE, CSP, ARM,  
CPHRM**  
President  
SafetyLogic Systems  
Austin, TX  
[dsine9@gmail.com](mailto:dsine9@gmail.com)  
[www.safetylogicsystems.com](http://www.safetylogicsystems.com)  
SafetyLogic Systems

**bhfc** Behavioral Health Facility Consulting, LLC

Assisting Organizations with Design of the Built Environment & Patient Safety Reviews

## SHARE YOUR BRIGHT IDEAS



A continuing feature in this updated edition is the inclusion of **Bright Ideas**, which are indicated by the graphic shown at the left. These are applications that we have thought of, or that have been suggested by readers, that do not require the use of any specific product, but make use of readily available items in creative ways to improve the safety of behavioral health units. Most of these **Bright Ideas** can be implemented by maintenance staff at nominal cost. We thank those who have contributed these ideas and information on new products. We encourage this kind of input and invite feedback from you, the readers. With your help, this can become a compilation of the best thinking of the industry. We promise to include more of your **Bright Ideas** in the future.

## ACKNOWLEDGMENTS

We want to express our appreciation to the following professionals who have shared their insight and experience with us and helped make this edition more helpful to other readers:

Larry Denoyer – The Menninger Clinic  
Steve Lindquist – Avera McKennan Behavioral Health Services  
Tom Hess – Sheppard Pratt Health System  
Byron Kitagawa – Sharp Healthcare Corp.  
Steve Sullivan – Britton Construction  
Tim Rappold – The Good Shepherd Center  
Tom Ferrel – Systems West Engineers  
Steven Shilts, RN – La Jolla Veterans' Medical Center  
Tom Loats – St. Joseph Hospital  
Carter Wright – CWC Corporation

## A WORD FROM BHFC

While *The Design Guide for the Built Environment of Behavioral Health Facilities (Design Guide)* addresses the built environment for adult inpatient behavioral health care units and remains co-authored by James M. Hunt, AIA, president of Behavioral Health Facility Consulting, and David M. Sine, DrBE,ARM, CSP, CPHRM, president of SafetyLogic Systems it continues to evolve.

The evolving *Design Guide* has found itself on the move once again as it leaves our friends at the Facilities Guidelines Institute or FGI and now moves to a new home on the Behavioral Health Facility Consulting, LLC (BHFC) website, [www.bhfcllc.com](http://www.bhfcllc.com). We find this move necessary in order to preserve the independence of the *Design Guide* and, through affiliate relationships, to provide even more organizations and their members access to a document that addresses leading practice design challenges of the built environment for adult inpatient behavioral health care units.

Some of the elements of the *Design Guide* for designing behavioral health facilities, such as the Patient Safety Risk Assessment tool, will continue to appear in the FGI *Guidelines for Design and Construction of Hospitals and Outpatient Facilities*. The *Design Guide* provides much more detail and leading practices for protecting patients and staff as identified through the authors' years of practice in the field. The *Design Guide* is not intended as a replacement for regulatory requirements nor to be employed as a legal "standard of care." Its content is provided to augment the fundamental design requirements for behavioral health facilities and to help providers and design teams develop physical environments that support safe and effective behavioral health services.

As always, we should remind readers that the *Design Guide* does not discuss the additional concerns that must be addressed when designing behavioral health facilities for child and adolescent patients, patients with medical care needs, geriatric patients, or some patients with diagnoses such as substance abuse and eating disorders.

Information is included about products that have been found to be more safe for use in the behavioral health built environment but is in no way a complete list of products available that may be appropriate, while recognizing that no product is entirely without risk. We should also point out that the editors vigorously resist offers to monetize the *Design Guide* or be compensated by enthusiastic vendors.

The *Design Guide* is updated periodically, and while we trust you will find the latest changes helpful, our goal is to provide updates more frequently than has been possible in the past, so please return to these pages occasionally to make sure you are referring to the most current edition.



## GENERAL COMMENTS

### Space Planning Considerations

- A. **Behavioral health units and facilities should be designed to appear comfortable, attractive, and as residential in character as possible.** The focus on patient and staff safety has often pushed the aesthetics of these units toward the appearance of a prison environment. To better meet the needs of patients, the final design must avoid an “institutional look” while meeting the array of applicable codes and regulations and addressing the therapeutic and safety needs of patients and staff. The challenge is to strike a balance between the safest possible healing environment and a non-institutional appearance that is correct for the unique conditions that exist in each facility.
- B. **Nurse stations should provide the least possible barrier between staff and patients.** This goal is sometimes felt to conflict with staff safety concerns as patients may be able to reach or jump over counters, but some facilities have found ways to design nurse stations that protect against these actions without preventing conversation and exchange of objects between staff and patients. HIPAA (Health Insurance Portability and Accountability Act of 1996) privacy regulations can make use of an “open” design challenging because patient records, electronic or otherwise, must be protected from view by other patients, visitors, and unauthorized staff. However, advancements in electronic medical records have somewhat reduced the need to locate all charting-related activities and spaces in the area behind the nurse station. Since the electronic “chart” can be accessed from many locations, the area around the nurse station can often be used for more patient-centered activities. When a more open nurse station is achieved, other areas where clinical staff can discuss patients without being overheard and appropriately secure storage for charts and patients’ valuables are needed.
- C. **Location of gathering areas for patients near the nurse station is encouraged because patients often congregate by the nurse station to socialize.** It is far better to plan for this behavior and accommodate it in the original design. Such gathering areas should include comfortable seating and places for conversation, card or board games, and other quiet activities that will not distract staff working in the nurse station. Television sets, CD players, etc. should not be included at these locations.

Many facilities are now experiencing issues, especially with younger patient populations, regarding use of personal electronic devices (e.g., iPods, MP-3 players, and similar devices). Patients say these electronics help keep them calm, but the wires on the earphones can be hazardous. The decision about how to handle this potential hazard is just one of many decisions that behavioral health

organizations need to weigh to determine the level of risk they are willing to accept for the perceived benefit. It should always be remembered that a patient who has been assessed as safe to use a player may set it down where another patient may pick it up to gain access to the wires.

- D. **Chart rooms and other staff areas should be located so staff members can have conversations regarding patients and other clinical matters without being overheard by patients or visitors.** Teaching hospitals that have a large number of residents and/or students making rounds will need larger spaces for confidential conversations. The expanded use of electronic medical record technology is continuing to change the needs and configurations of these spaces.
- E. **Facilities for medication distribution should support the organization's practices but allow for flexibility.** Medication management has evolved over the years from patients lining up at a window at designated times to staff taking medications to patients wherever they are on the unit. While the trend is strongly toward the latter, some facilities prefer the former or some variation of the two. This practice should be clearly defined for every facility, and flexibility should be designed into the built environment to allow for future changes in how this critical function is provided. Medication rooms and/or zones should be sized to accommodate the number of staff who will be necessary at peak times and designed for current and future computer systems. HVAC and electrical systems should have sufficient capacity to accommodate the cooling load of the refrigerator, computer, automated medication systems, and number of people who may be working in the area at peak times. The medication area should also have a hand-washing sink and be sized to accommodate storage of the medication cart when it is not in use without restricting staff use of the space. (See Section 2.1-2.6.6.2 (1) in the FGI *Guidelines for Design and Construction of Hospitals and Outpatient Facilities*, 2014 edition.)
- F. Where possible, **locate service areas (such as trash rooms and clean and soiled utility rooms) so they are accessible from both the unit and a service corridor.** This eliminates the need for environmental staff servicing these rooms to enter the treatment areas of the unit and possibly disturb patient activities. All doors to these rooms must be kept locked at all times.
- G. **Traditional nurse call systems for patients to request assistance from nursing staff are not required** in behavioral health units. Significant new developments in duress alarm systems greatly improve safety for staff who find themselves threatened by patients. Sensors located in all patient-accessible areas are activated using a small device that the staff members wear.<sup>650</sup> Staff activate the alarm when they feel threatened and want other staff to come. Different alarm products announce in different ways, but many provide the exact location of the staff member activating the alarm.
- H. **All electrical outlets in patient rooms should be tamper-resistant, hospital-grade units on ground-fault interrupted circuits.** The breakers for these circuits should be located so staff can easily access them without entering patient rooms.

This is easy to accomplish in new construction, but can be very difficult to achieve in remodeling projects. If receptacles with individual reset buttons are provided, they should be wired so that activation of one receptacle's breaker does not deactivate the entire circuit.

- I. **All electrical circuits with receptacles near water sources (e.g., sinks, lavatories, and toilets) must be protected by ground-fault circuit interrupted (GFCI) breakers.**
- J. Where possible, **locate water shut-off valves in corridor walls so they can be accessed from the corridor by opening a locked access door.** This has been successfully accomplished during remodeling projects of existing units.
- K. Where possible, **locate serviceable parts of patient room HVAC systems where they can be serviced without entering the room.** In new construction, consideration may be given to radiant heating and cooling systems that greatly reduce the need for mechanical devices in patient rooms.
- L. **Housekeeping rooms should be large enough to lock away carts when not in use.** All cleaning materials must be locked inside these carts at all times when carts are in patient areas or corridors and not attended by staff.
- M. **Smoking areas (if provided) should be outdoors.** These can be screened-in porches using heavy stainless steel screen fabric<sup>81</sup> similar to that specified in Level III-H.1 in this document. Furniture should be securely anchored in place. Provision should be made for staff observation without having to breathe secondhand smoke. No wastebaskets should be allowed in these areas. Indoor smoking is not permitted in most facilities, and many hospitals have gone to smoke-free campuses.
- N. At the time of this writing, **the applicable standards** (the FGI *Guidelines for Design and Construction of Hospitals and Outpatient Facilities*, 2014 edition, published by the Facility Guidelines Institute) **require 100 net usable square feet per private patient room and 80 net usable square feet per patient in semi-private rooms (Section 2.5-2.2.2.2).** All requirements of the FGI *Guidelines*, NFPA 101: *Life Safety Code*® (2012 edition), and the Joint Commission standards as well as state and local regulations and building codes must be incorporated into project planning.

## 2. Safety

The level of concern for how the design of the built environment affects the safety of patients and staff is not the same in all parts of a behavioral health unit or facility. The level of precautions necessary depends on the staff's knowledge of the patient's intentions regarding self-harm and the amount of supervision the patient will have while using that part of the facility.

Previous editions of this *Design Guide* have proposed that the level of concern for patient safety in the behavioral health built environment can be stratified into five categories (with five being the highest level of concern). The concept is that some latitude in design, construction, and materials used could be allowed for the lowest

level (Level I), described as spaces having no patient access or spaces where patients are under constant supervision (e.g., staff and service areas). Much stricter requirements would need to be met for Level IV, described as an area where patients with unknown or unassessed risks are present or an area in which highly agitated patients could be cared for. Level V areas are those that present special considerations that need to be addressed individually. The concept of this level system has been confirmed by independent and peer-reviewed research (Bayramzadeh, S, *Health Environments Research & Design Journal* 2017, Vol.10(2) 66-80).

Many have adopted this approach of assessing levels of concern based on a functional statement of intended use and have agreed on the level of risk for rooms or spaces with similar occupant functions (e.g., admissions rooms, examination rooms, etc.). However, caution is necessary as some rooms or room functions can fit comfortably into more than one category or sit on a blurry boundary between two categories. As well, the categories do not anticipate every use of every room. This blurriness can result in clinical staff and facility designers basing design choices on assumptions about the use of a room and its corresponding level of concern that may not meet the actual needs of the stakeholders in an operating environment. For example, a day room may be located within the sight line of a nurse station that “always has staff present.” However, if a patient who can’t sleep is in the day room watching television at 2 a.m. and the only staff member on duty is making rounds, the patient may be “completely alone” for a period of time in a space that may contain hazards.

The authors of the *Design Guide* propose use of a patient safety risk assessment (PSRA) to facilitate conversation between clinical staff and designers regarding patient safety. The PSRA uses a Cartesian matrix to relate an opportunity for a patient to be alone in a space on one axis to a level of risk of self-harm on the other axis. The greater the opportunity for a patient to be alone, the greater the opportunity for self-harm and the greater the caution that should be taken regarding design choices and materials.

Although patient intent for self-harm is often opaque and difficult to assess, in the matrix we have placed “actively suicidal” on the far end of the scale and describe the opposite end as “self-harm not anticipated.” Privacy ranges from close observation (such as “1:1 observation”) on one end of the opportunity scale and the patient “completely alone” on the opposite end.

This risk matrix is informed by Veterans Health Administration longitudinal studies that have identified frequent locations of acts of self-harm by inpatients, Joint Commission data, and Richard Prouty’s seminal work on risk maps. Designers and clinicians, rather than seeking agreement on what is meant by the name of a room, may now seek to agree on the actual or anticipated degree of aloneness or privacy a patient will experience in a room or space (independent of its name), and it is that agreement that will drive design choices for the room or space.

For example, a patient bathroom in which the patient is anticipated to be alone and have privacy would be far along the privacy axis. If that assessment intersects far along the patient intent for self-harm axis, the space should be designed with the attributes of a Level IV space as described in this document. In sum, no matter the name of the room, a high level of privacy warrants a high level of concern if it is anticipated that patients who are

actively suicidal (or patients with an unknown or unassessed intent for self-harm) are to be treated or housed in that space. While different products may be used for spaces with risk

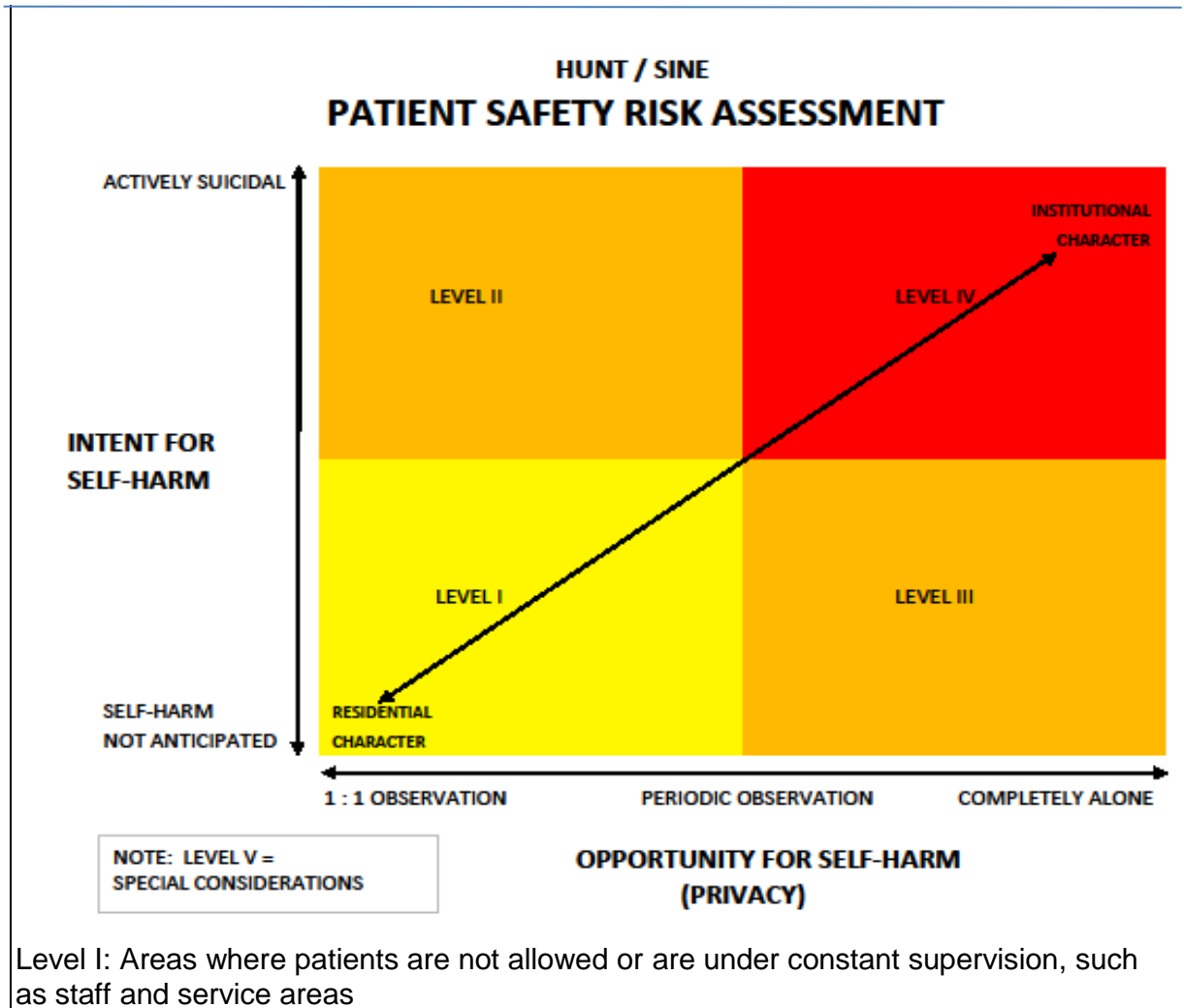

Level II: Areas behind self-locking doors where patients are highly supervised and not left alone for periods of time such as counseling rooms, activity rooms, interview rooms and corridors that are fully visible.

Level III: Areas that are not behind self-locking doors where patients may spend time with minimal supervision such as lounges, day-rooms and corridors that are not fully visible.

Level IV: Areas where patients spend a great deal of time alone with minimal or no supervision, such as patient rooms (semi-private and private) and patient toilets

Level V: Areas where staff interact with newly admitted patients who present potential unknown risks or where patients may be in a highly agitated condition. Due to these conditions, these areas fall outside the parameters of the risk map and require special considerations for patient (and staff) safety. Such areas include seclusion rooms, examination rooms, and admission rooms.

---

assessments located in the Level IV quadrant of the risk matrix than for spaces in the Level I quadrant, the higher risk locations do not necessarily need to look more “institutional.”

The authors believe the use of a tool such as the patient safety risk assessment matrix will facilitate necessary conversations regarding patient safety and design between operators, clinicians, and designers. However, the tool is not intended to predict risk levels in a facility, which the authors believe to be dynamic and non-static. Rather, it is intended to encourage dialog and promote a common understanding of the patients a designed space is intended for and the risks of that anticipated patient population.

Also note that use of the matrix should not be interpreted as a suggestion that patient privacy is not important or is a risk to be avoided. On the contrary, privacy is generally considered desirable in the behavioral health built environment, although it is associated with a risk that should be considered and mitigated through good design where possible.

### **3. Outdoor Areas**

Outdoor areas (e.g., enclosed courtyards, fenced areas adjacent to a treatment unit, or an open campus) are considered to have great therapeutic benefit. Because levels of staff supervision for patients using outdoor areas may vary widely between facilities, or even between different groups using the same space at different times, the need for supervision should be carefully reviewed by management early in a design and construction project. The final design for outdoor areas must respond to the acuity and assessment of the most acute patients using the area.

In all cases, careful consideration should be given to exterior landscaping and furniture in the vicinity of buildings used by patients. Trees should be located away from buildings to prevent access to roofs. Climbable fences can permit, if not encourage, unauthorized access to windows and roofs or elopement over walls. Shrubbery should be non-toxic and low-growing. Avoid planting shrubbery close together as it can create visual barriers that patients or unauthorized visitors may hide behind. Landscape or decorative rocks that can be thrown and injure staff or other patients should not be used.

All outdoor furniture<sup>660</sup> should be firmly anchored in place. This will prevent the furniture from being moved to create barricades or stacked to allow climbing over fences, into windows, or onto buildings. Many types of commercially available furniture can be anchored or are made of concrete or other heavy materials.

Buildings, walls, or fences may be used to establish clear boundaries and impede elopement to a degree appropriate to the patient population being served. Some behavioral health organizations are comfortable with a perimeter enclosure that is not particularly difficult to climb and simply make elopements a treatment issue if the patients return. Other organizations have a very high need to reduce elopements to the

extent possible. Where this is the case, the enclosures may take on a very prison-like appearance. If views to the distance are not required, one approach is to treat the outdoor areas as meditation gardens with solid masonry walls that have a smooth interior surface and are 12 to 14 feet high.

One facility installed large diameter (22"-24") plastic pipe on top of the wall to make it difficult for patients to get a grip on the top surface. This pipe can be painted to match the color scheme of the building and provides a much less institutional appearance than concertina wire. If views to the distance are desired, "windows" glazed with polycarbonate<sup>201</sup> or security glass<sup>200</sup> may be used. These view panels should not have sills or cross bars that could provide footholds for climbing.



Another option is installation of a fine mesh chain-link fence fabric<sup>675</sup> on top of existing fence material. This fabric, which comes in a range of sizes down to as small as 3/8" openings, makes the fence more difficult to climb and has openings that are too small for most bolt cutters. When installing such material, fence posts and rails must be strong enough to support the fabric and the wind loading it will add. In at least one instance, a patient successfully climbed a mini-mesh fence, so it is suggested a section at the top be angled inward to further increase the difficulty of climbing.

Maximum security fencing,<sup>676</sup> which has a very prison-like appearance, may be selected for some facilities with involuntarily admitted patients. However, use of less institutional-looking solutions should be explored before deciding to use this material.

Where portions of the building walls will enclose exterior courtyards for patient use, these walls should not be easily climbable, especially if they are only one story high. Windowsills, rain gutters, and similar features may support efforts to climb walls to gain access to the roof. The exterior surface of all windows patients can access from exterior courtyards must have security glazing,<sup>200</sup> polycarbonate glazing,<sup>201</sup> or security window film,<sup>190</sup> as described under Level II-D.

All areas surrounding patient use buildings, areas where staff will walk or escort patients at night, and courtyards should be well-lighted. Exterior lights should not shine directly into patient room windows.

Parking areas for staff and visitors should be well-lighted and reviewed regularly for design features that encourage personal and property security. While security is generally beyond the intended scope of this document, closed-circuit television monitoring and video surveillance recording of these semi-public areas, where there is no expectation of privacy, should be considered.

All manhole covers, access panels, and area drain grates should be anchored firmly in place to discourage easy removal and use as weapons and to make it difficult for patients to enter the underground piping.

## CONSTRUCTION AND MATERIALS CONSIDERATIONS

Each level of concern in the patient safety risk assessment matrix requires increased attention to the built environment to reduce the potential for patients harming themselves or others. The levels are cumulative, and all steps taken for lower levels are also required for the next higher level. For example, all steps recommended for Levels I, II, and III are also recommended for Level IV.

### Level I. Staff and Service Areas

Comply with all applicable codes and regulations. All unattended service areas should be locked at all times to reduce the possibility of patients entering these spaces.

### Level II. Corridors, Counseling Rooms, and Interview Rooms

Minimize blind spots in corridors where patients cannot be observed from an attended nurse station. All unattended counseling and interview rooms should be locked at all times to reduce the possibility of patients entering these areas. Counseling rooms and interview rooms should have a “classroom”-type lockset that requires a key to lock or unlock the outer handle, but the inside handle is always free.

- A. **Floors** – Carpet<sup>255</sup> or sheet vinyl<sup>245</sup> meeting class A rating should be used. Avoid patterns and color combinations that may appear to “animate” into objects that could contribute to visual misperception by patients. Anti-microbial carpet with solution-dyed yarn and moisture-resistant backing generally works well in these facilities and is available from most major carpet companies.
- B. **Walls** – Abrasion-resistant and impact-resistant gypsum board<sup>230, 231</sup> hung on 20-gauge or heavier metal studs spaced no more than 16 inches on center is typically considered minimum construction for these areas. Sound-deadening gypsum board<sup>232</sup> is now available to help reduce noise levels from traditional hard services. Consult manufacturers regarding the characteristics of the material determined most appropriate for a particular installation. These products are available from several manufacturers.

A painted finish is preferred because it is easy to repair and the cost of renewing or changing colors to keep up with current trends is relatively low. Also, painted finishes help create a residential or home-like ambience while still meeting institutional requirements.

- C. **Ceiling** – A solid ceiling is preferred for all areas of a behavioral health facility. However, where accessibility to mechanical, electrical, and communication equipment is needed, a lay-in ceiling may be used if the ceiling is high enough to make the tiles and grid system difficult to reach. Where a lay-in ceiling is used,



consideration should be given to the use of clipped-in-place ceiling tiles. If clips are used, regular safety rounds should include checking to see that they remain in place as often clips are not replaced after maintenance is performed on equipment above the ceiling. Some facilities report installing motion sensors above lay-in ceilings to alert staff to patient activity above the ceilings.

D. **Glazing** (Interior and Exterior) – When it is broken, all glazing that is exposed in patient-accessible areas should stay in the frame and not yield sharp shards that patients could use as weapons. Terminology can be confusing in that laminated glass like that used in vehicle windows is often referred to as “safety glass” but, when broken, can yield large sharp pieces. Some forms of glazing recommended for use in behavioral health facilities are listed here:

1. **Standards** – All glazing in patient-accessible areas should be safety glass.

The 2018 edition of the FGI *Guidelines for Design and Construction of Hospitals* will contain the following reference to window testing:

**“2.5-7.2.2.5 Windows...**

“(2) To prevent opportunities for suicide, self-harm, and escape, the entire window system and the anchorage for windows and window assemblies, including frames and glazing, shall be:

“(a) Designed to resist impact loads of 2,000 foot-pounds applied from the inside

“(b) Tested in accordance with AAMA 501.8-13: *Standard Test Method for Determination of Resistance to Human Impact of Window Systems Intended for Use in Psychiatric Applications*. Where operable windows are used, hinges and locking devices shall also be tested.”

2. **Impact-Resistant Glass Products** – Several glass manufacturers<sup>200</sup> offer products that may be appropriate for use in behavioral health facilities. The products chosen will vary depending on the size of the opening, type of frame, patient population being served, and location of the glazing in the unit (as determined by the patient safety risk assessment) including the distance the opening is above grade. We suggest contacting manufacturers directly to determine which products may be appropriate for a specific project.

a. **Heat-Strengthened Glass** – Although more difficult to break than regular float glass, heat-strengthened glass has about half the strength of tempered glass. Heat-strengthened glass may be a good choice if it is laminated and high-impact resistance is not required for the location.

b. **Tempered Glass** – This may be acceptable for use in some patient-accessible areas such as small windows in doors, portions of glass walls separating activity rooms from corridors, and patient toilet room mirrors. Tempered glass is more impact-resistant than float glass or laminated glass,

but will break into many small pieces and fall out of the frame, which may allow a patient to elope. As well, each piece may have sharp edges. Patients have been known to break tempered glass mirrors and rub the inside of their wrists on the broken surface to cut themselves or swallow the small pieces of glass. This hazard may be reduced by covering the tempered glass with a security film as described below.

- c. **Tempered/Laminated Glass**<sup>200</sup> – Two layers of tempered glass are bonded to a PVB interlayer, which helps the glass stay in the frame when broken.
- d. **Glass-Clad Polycarbonate Glazing**<sup>200</sup> – Two layers of heat-strengthened glass are bonded to a polycarbonate core. This combination keeps the broken material in the frame and reduces patient access to shards of glass that could be used as weapons.
- e. **Window Film** – If replacing existing glass is cost-prohibitive, applying a window film security laminate<sup>190</sup> to existing glass may be an alternative. Although these films are susceptible to scratching and defacement by patients, they may be removed and replaced at less cost than replacing glass or polycarbonate panels. Additional protection may be obtained by using impact-protection adhesives and a perimeter tape system to help hold the glass in the frame if broken. In our opinion, claims that these window films will prevent glass from breaking should not be relied upon.
- f. **Wire Glass** – This will break and yield sharp shards of glass and is generally not permitted by many current codes and regulations. Any use of wire glass should be verified with all authorities having jurisdiction as many codes have placed restrictions on its use.
- g. **Fire-Rated Glass**<sup>205</sup> – Clear fire-rated glass products are now available in a variety of types and ratings.
- h. **Polycarbonate**<sup>201</sup> (Lexan) – Polycarbonate panels are highly impact-resistant and available in a variety of thicknesses from several manufacturers. These products will deflect upon impact, and large pieces have been known to pop out of their frames. Care should be taken to assure that the depth of the stop securing the panel will be able to hold it when subjected to strong impact near the center of the panel. This material is also highly susceptible to scratching and is a frequent target of patients who write profanity and draw pictures. Mar-resistant coatings are available, but they do not eliminate this concern. Recent projects have indicated this may be the most expensive option.

## E. Doors

1. **Elopement Buffers** (formerly called sally ports) – The FGI *Guidelines* calls for the “primary access point to the locked unit to be through a sally port” (Section 2.5-2.2.1). A sally port has two doors (or two sets of cross-corridor doors) that are spaced far enough apart for the first door to be closed and locked before the second door is allowed to unlock.

2. **Access Control** – Provide intercom (or telephone) for communication to nurse stations from outside the unit if needed. Electronically controlled access systems are preferred. These may be operated by a switch at the nurse station if the door is clearly visible from the location of the release button. (Care should be taken to assure that patients are not in the area when the door is released.) Card readers or keypads adjacent to the door are also commonly used. These are readily available from hardware suppliers and are generally extensions of systems already in place at the facility.
3. **Cross-Corridor Doors** – These doors are provided for several reasons, and each has its own unique function and requirements. Often, they are required to be locked as a rule and to automatically unlock when the fire alarm is activated (fail safe operation). When there is concern that electromagnetic locks may not be sufficient to hold these doors, concealed deadbolts with the electric release in the lever handle<sup>109</sup> may be provided.
4. **Other Doors** – Doors in behavioral health facilities are subject to heavy use and possibly extensive abuse. They make up a significant percentage of the exposed wall surface in corridors and thus have a strong visual impact on these spaces.

Painted steel doors are durable, easily touched up or refinished, but more institutional in appearance. Doors with wood veneer faces and stain and varnish finish are more “residential” in character, but are easily damaged and difficult to repair. Plastic laminate covered doors are also easy to chip on the edges and may soon become unsightly. One way to address the damage these doors receive is to add stainless steel kickplates, door edges, and other add-on devices, although these add to an institutional look. (NOTE: The installation of kickplates may invalidate the fire rating of doors in some jurisdictions.) Kickplates and other protective devices are also available in durable synthetic materials that come in a variety of colors, which soften the stainless steel look but can still result in a patchwork appearance.



A possible solution to these issues is doors faced with a durable synthetic that has a wood grain appearance. Some of these doors have removable end caps,<sup>25a</sup> which can be replaced if they become damaged at much less expense than replacing the entire door. Doors with synthetic faces without the replaceable end caps<sup>25b</sup> are available for a lower initial cost.

Although the first cost for these synthetic-faced doors is higher than for doors of other materials, they do not require the added expense of finishing the doors and purchasing and installing kickplates, etc. Thus, the life cycle cost can potentially be much less than for other doors, and the appearance over time may be a significant improvement.

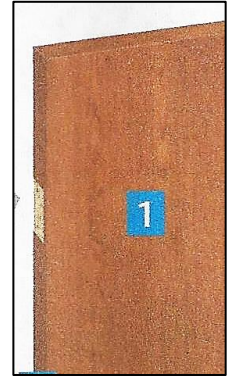

## F. Hardware

1. **Hinges** – Geared-type continuous hinges are preferred for all patient-accessible areas because they minimize possible attachment points. These hinges are available with a closed-sloped top and continuous gears that resist ligature attachment.<sup>111</sup>
2. **Closers** – Closers are generally not required for patient room doors in most jurisdictions, but may be required for other doors. Where installed, it is suggested that track closers<sup>100</sup> be mounted on the corridor side of the door, away from rooms where patients will be alone or in groups.

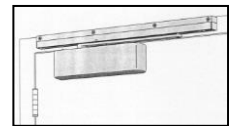
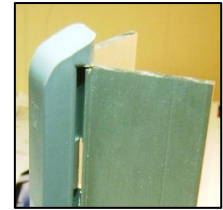

3. **Locksets** – Use of some type of ligature-resistant lockset is recommended for all doors in patient-accessible areas. A lockset can be used for ligature attachment in three ways: pulling down, pulling up and over the top of the door, and tying something around the latch edge of the door using both the inside and outside handles (transverse). The latchbolt itself has even been used successfully as an attachment point as has the opening behind the strike plate; for this reason, a box should always be provided behind the strike plate. In our opinion, the perfect solution for this dilemma does not exist at this time. Several of the better options are discussed below.



- a. Locksets with a Lever Handle<sup>130</sup> – These effectively deal with up and down pressure, but are susceptible to transverse attachment. The lever should move freely in both directions when locked to reduce ligature attachment risks. This type of handle is more typical (less institutional) in appearance and operation than other choices. Both of these qualities are very desirable in items that patients will touch and use on a regular basis. However, lever handles may present more risk than some of the other choices.



b. Crescent Handle Lockset<sup>136</sup> – This type of lockset has a lever handle and thumb turn that are ligature-resistant and may meet ADA requirements. It is available with a handle that can be mounted in a horizontal position and allows the user’s hand to easily slip off the free end.



c. Push/Pull Handle Locksets<sup>137</sup> – When installed with both handles pointing down, this type of lockset resists pulling down and, to some extent, transverse attachment. However, it is very easy to pull up on the handle and loop something over the top of the door. This hazard can be reduced by installing an over-the-door alarm as discussed later in this document.

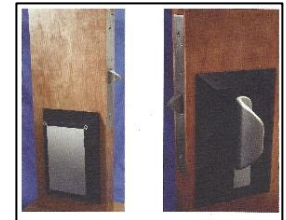

d. Push/Pull Hardware – This type of door handle is available with a flush push pad on one side and a ligature-resistant pull handle on the other.<sup>137b</sup>

e. Modified Lever Handles – These provide minimal ligature attachment risk but have an unusual appearance and operating motion. They are available in various designs.



4. **Unit Entrance Door Hardware** – Electronically controlled access systems with electric strikes or electromagnetic locks are preferred. See Level II-E-2 (Doors – Access Control).

The two doors or two sets of cross-corridor doors in an elopement buffer (sally port) are electronically interlocked so that only one door can be open at a time. Care should be taken to assure that adequate space is provided for both doors to be closed at the same time. Packaged systems for this hardware<sup>144</sup> can be used to satisfy this requirement.

5. **Exit Door Hardware** – Exit doors (including stairway doors) in behavioral health facilities are often locked at all times. They may be locked with electromagnetic locks<sup>110</sup> connected to the fire alarm system and may stay locked when the fire alarm is activated (fail secure) or release when the alarm is activated (fail safe) as deemed



appropriate for the patient population. The acceptability of this type of hardware and its operating mode should be verified with the local authorities having jurisdiction. Electromagnetic exit door locks are available in varying holding strengths, and the mounting position recommended by the manufacturer must be carefully followed to provide the rated holding force. For extraordinary circumstances, more than one electromagnetic lock can be provided per door or

electrically operated deadbolts or a vertical frame member at the strike jamb may be required.

## 6. Hardware for All Unit Doors

a. Doors for which applicable codes and regulations require a closer but that need to be open to allow staff observation of patients must be provided with a closer with a built-in release<sup>101</sup> that permits the door to close automatically when the fire alarm is activated.

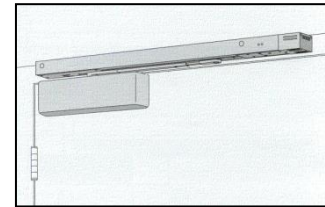

b. For doors that swing into rooms with patients in them, one of the barricade-resistant methods discussed in Level IV-a should be used.

7. **Door Smoke Seals** – These may be required in some situations and are often applied with adhesive strips that can allow patients to remove them to use as ligatures. Smoke seals that break into 8”-long pieces<sup>10</sup> are preferred for use on all doors that patients will pass through.

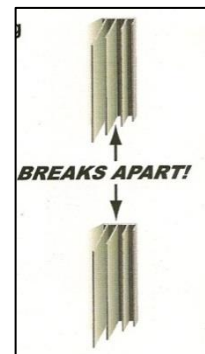

8. **Hardware for Toilet and Shower Rooms** – Patient-accessible toilet rooms and shower rooms located near activity rooms and other locations on the unit should have all the features of the patient toilet rooms discussed in Level IV-b. In addition, they will need to have a “classroom function” locking device to limit both unauthorized use and entrance by others when in use.

**G. Light Fixtures** – If located at a height or location that is not easily accessible to patients, these may be normal fixtures and lamps as long as staff observation from the nurse station is good and staff are in attendance; however, tamper-resistant fixtures are preferred. Where fixtures can be reached by patients or in areas that are not readily observable by staff, light fixtures must be a tamper-resistant type<sup>620</sup> or have minimum ¼”-thick polycarbonate prismatic lenses<sup>634</sup> securely fixed in the frame with covers that are firmly secured with tamper-resistant screws.<sup>470</sup> Many such fixtures are now available with LED light sources.



Glass components that could be accessed by patients should not be used in any fixture. Use of table lamps or desk lamps is strongly discouraged. Neither incandescent lightbulbs nor fluorescent tubes should ever be accessible to patients.



Motion detector control of corridor light fixtures (other than minimal night-lighting) has been suggested. This would allow staff to know immediately when a patient leaves his or her room.



H. **Fire Sprinklers** – Institutional heads<sup>521</sup> that provide very little opportunity for attachment should be provided.



### I. HVAC Grilles and Equipment

1. Standard grilles with small perforations<sup>600</sup> that are secured in place with tamper-resistant fasteners are generally acceptable in corridors, counseling rooms, and interview rooms as long as they are mounted high enough that patients cannot easily reach them.
2. Where existing fan/coil units (as well as fin-tube heaters or old style radiators) are present in these spaces, they should be protected with vandal-resistant covers.<sup>606</sup>

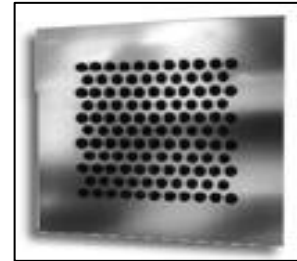

### J. Window Coverings

1. **Mini-Blinds** – Mini-blinds mounted between layers of safety glass<sup>200</sup> are preferred because the blinds are not accessible to patients. Care should be taken to assure that any exposed devices for controlling the tilt of the blinds do not create a potential ligature attachment point. Some commercially available window assemblies have all these features.<sup>430</sup> Exposed mini-blinds should never be used.

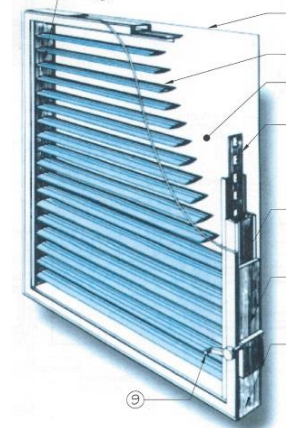

2. **Roller Shades**<sup>440</sup> – Roller shades specifically manufactured for use in psychiatric hospitals are another option. These have enclosed security roller boxes, security fasteners, cordless operation, and locking devices that resist tampering by patients.



3. **Curtains and Curtain Tracks** – Curtains and associated tracks of any type (including those designated as “breakaway” and represented by their manufacturers as “safe for psychiatric hospitals”) are not recommended for use in any patient-accessible areas, especially patient rooms and patient showers.

K. **Operable Windows** – Windows in all patient-accessible areas should comply with all applicable codes and regulations for operable sash. Where operable windows are provided, they should be equipped with sash control devices<sup>170</sup> that limit how far the window can be opened and that, where required, can be released to full opening using a key for evacuation purposes. Window systems are also available that allow fresh air<sup>434</sup> through a rotating vent at the bottom or by sliding the window open a few inches.



L. **Miscellaneous**

1. **Trash Can Liners** – Plastic trash can liners should not be allowed in any space accessible to patients. Breathable paper liners<sup>1</sup> should be provided.

2. **Telephones** – Telephones located in corridors or common spaces for patient use should have a stainless steel case,<sup>655</sup> be securely mounted to the wall, and have a non-removable shielded cord of minimal length (14 inches maximum); they may be equipped with or without touch pads for placing outbound calls. It has been reported that if a patient pulls very hard on the receiver that the armored cable can unwind and provide sharp edges. This risk should be weighed against the ease of removal of standard cords.



3. **Cabinet Pulls** – These should be recessed, with no protruding openings, or of a closed ligature-resistant type.<sup>460</sup>

4. **Cabinet Locks** – These are very important in all patient-accessible areas. Cabinets used to store items that patients could use to harm themselves or others should be kept locked at all times when patients are present. This can lead to staff constantly looking for the right key on a large keychain. One solution is to provide locks that can be unlocked with a key that staff already carry, such as the key used to activate the fire alarm. Another solution is to use existing key access cards or a pushbutton keypad.<sup>465</sup> These are becoming more affordable and should be particularly helpful in examination/treatment rooms and any locked cabinets in patient rooms.



5. **Room Signs**<sup>300</sup> – Room signs are available in a flexible material that is applied with adhesive and will not provide a weapon to patients if removed. These can include braille lettering and meet ADA requirements.





**6. Fire Response Equipment** – All fire alarm pull stations and all fire extinguisher cabinets<sup>521</sup> should be locked (with approval of all applicable code authorities). All staff on duty must carry keys for these at all times. These keys should be provided with a red plastic ring or other means of providing quick identification. In addition, fire extinguisher cabinets should have continuous hinges, recessed pulls (if any), and polycarbonate glazing if view windows are provided.



**7. Lighted Exit Signs<sup>640</sup> or Photoluminescent Signs<sup>642</sup>** – These should be vandal-resistant and installed tight to the ceiling with a full-length mounting bracket to avoid use as a hanging device. Mounting these signs on a wall so they are perpendicular to the wall is not recommended because it leaves the top exposed as a possible attachment point.



**8. Observation Mirrors** – Convex mirrors installed in corridors, seclusion rooms, and other patient-accessible locations to assist with observation of patients should be made of a polycarbonate that is a minimum of 1/4" thick, be filled with high-density foam, and have a heavy metal frame that fits tightly to the wall and ceiling.<sup>420</sup> Convex mirrors made of steel are also available. The perimeter of the mirror should be sealed with pick-resistant caulking.<sup>20</sup>



## M. Furniture

1. Furniture used in behavioral health facilities should be easily cleaned, easily reupholstered, very sturdy, and as heavy as possible to minimize the likelihood of patients throwing chairs, tables, etc. As much furniture as practical should be built-in or securely anchored in place to prevent stacking or barricading of doors. Remaining loose items (such as chairs) can vary from high-quality wood- or steel-armed upholstered chairs<sup>482</sup> that resemble typical residential furniture to polyethylene rotationally molded<sup>483</sup> and sand-ballasted seating, which is now available with a less institutional look. The health care organization should select furniture appropriate for the patient population served.



2. Lockable storage cabinets and drawers should be provided, along with the means to lock phones and computers away from patients. Some organizations have a switch installed in a staff area to deactivate patient use phones at times when patients are not allowed to make calls.

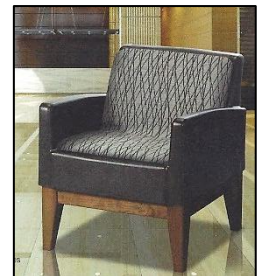

3. All upholstery and foam used in furniture should have flame-spread ratings that comply with the requirements of Section 10.3 of NFPA 101: *Life Safety Code*®.

N. **Pictures and Artwork** – All pictures and artwork in patient-accessible areas must be given special consideration:

1. **Murals** – These can brighten and add interest to corridors and day rooms and have been used very effectively in some facilities. It is usually a good idea to cover them with at least two coats of a clear sealer for protection, but patients typically enjoy these and defacing them is not usually a problem. Murals are also available on wall vinyl and wall protection materials.



2. **Wall Protection** – Large sheets of durable wall protection material are available with a wide variety of printed artwork.<sup>304</sup> However, the standard vinyl trim pieces that come with this material should not be used for behavioral health applications. Rather, the edges of the material should be tightly fitted together and sealed with pick-resistant caulk.<sup>20</sup>



3. **Frames** – Specially designed frames<sup>302</sup> that slope away from the wall and have polycarbonate<sup>201</sup> or acrylic glazing are recommended. The frames should be screwed to the walls with a minimum of one tamper-resistant screw<sup>470</sup> per side. Care should be taken to reduce opportunities for attaching ligatures to the frame or the joint between the top of the frame and the wall, especially when the surface of the wall is not perfectly flat, causing gaps between the wall and frame. The joint at the top should be sealed with a pick-resistant sealant.<sup>20</sup> Some of these frames allow for easy replacement of the images and provide the opportunity for patients to customize the displays with personal photos, etc.



4. **Printed Flexible Vinyl** – Another option is to print artwork on flexible vinyl<sup>301</sup> that can be attached to walls with low-tack adhesive or regular wall vinyl adhesive for more permanent installations. This method reduces the risk of patients obtaining harmful materials. The low-tack adhesive used on smaller images makes it easier to change the art displayed on a seasonal or other basis and allows hospitals to offer patients a choice of artwork to display in their rooms, giving them some control over their environment.

- O. **Ligature-Resistant Drinking Water Stations** – Drinking fountains are often required or desired in common spaces on units. Typical drinking fountains can prove problematic for ligature and infection control reasons, but requiring patients to ask staff every time they want a drink of water can rank high on patient dissatisfaction surveys.



To address this issue, consider use of water cup-filling stations in patient-accessible areas. Several options are available for cup-filling stations<sup>599</sup> that have either local or remote refrigeration units, in both wall-mounted and countertop styles.

### **Level III. Lounges and Activity Rooms**

- A. **Floors** – Use sheet vinyl<sup>245</sup> where wet or potentially messy activities will be conducted. Carpet should be broadloom or sheet carpeting and have antimicrobial, solution-dyed yarn and non-moisture absorbent backing.<sup>255</sup>
- B. **Walls** – Same as for corridors in Level II.
- C. **Ceiling** – Non-accessible, solid gypsum board ceilings are preferred. If more sound attenuation is desired, apply 1'x1' acoustic tile to the gypsum board with adhesive or use sound attenuation gypsum board.<sup>232</sup> A nine-foot-high ceiling is highly desirable as the added height makes it more difficult to reach, decreasing patient tampering with ceiling-mounted devices.
- D. **Glass** – Same as for corridors in Level II.
- E. **Hardware** – Same as for counseling and interview rooms in Level II.
- F. **Light Fixtures** – Same as for corridors in Level II.
- G. **Fire Sprinklers, Institutional Type** – Same as for corridors in Level II.
- H. **HVAC Grilles and Equipment** – Only grilles with very small perforations<sup>600</sup> that comply with National Institute of Corrections standards should be used in behavioral health facilities.
1. If other grille types exist and must remain, cover them with heavy-gauge stainless steel screen fabric<sup>81</sup> or a manufactured perforated cover.<sup>605</sup>
  2. If individual fan/coil-type units exist and must remain, secure all access panels, grilles, and controls. Same as for corridors in Level II-I.
- I. **Window-Covering Hardware** – Same as for counseling and interview rooms in Level II

**J. Furniture** – All lounge furniture requirements listed for counseling and interview rooms in Level II also apply to this level. Where movable seating is required (e.g., dining and activity rooms), very lightweight polypropylene chairs<sup>481</sup> that resist breaking into sharp pieces are preferred. An alternative is a chair that can be partially filled with sand to make it difficult to throw or use as a weapon.<sup>480</sup>



**K. Kitchen Appliances**

1. All cooking appliances (ranges, microwaves, coffee makers, etc.) should have key-operated lockout switches<sup>611</sup> to disable the appliance.
2. Patient access to coffee should be carefully considered in each facility’s risk management program. If access to this (and other potentially scalding liquids) is allowed, an insulated plastic dispenser should be located so it is readily observable by staff. Glass coffee pots should never be available to patients.
3. All garbage disposal units should have a key-operated lockout switch<sup>611</sup> to disable the device.
4. All receptacles located near sources of water, including sinks, as well as all patient-accessible receptacles must be GFCI-protected.

**L. Miscellaneous**

All miscellaneous requirements listed for counseling and interview rooms in Level II apply to this level also.

1. **Electrical Device Cover Plates** – All electrical device cover plates (for switches, receptacles, etc.) must be attached with tamper-resistant screws.<sup>470</sup> Cover plates made of polycarbonate<sup>612</sup> materials are preferred; each cover plate must have screws in each corner to make it rigid enough to resist bending and protect patients from access to electrical wiring and contacts. Standard stainless steel cover plates that fit tightly to the wall are rigid enough to be allowed for many patient populations. These may be secured with a single tamper-resistant screw in the center as long as it is securely tightened.

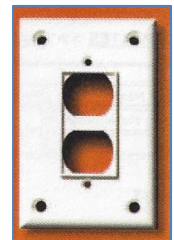

2. **Television** – TV sets should not be mounted on walls using exposed brackets because of the ligature risk this presents. Rather, all TV sets should be installed in built-in TV or media centers or manufactured tamper-resistant covers with sloped tops.<sup>290</sup> They should also have an isolation switch that staff can control.







For maximum safety, the electrical outlet and cable TV outlet should be located inside the cover to keep the wires and cables away from patients. One facility utilized unused platform beds mounted vertically on the wall to house television sets and conceal all wires and cables.

## Level IV-a. Patient Rooms

- A. **Floors** – Same as lounges and activity rooms in Level III. If some patients are prone to urinate on the floor, provide some rooms with seamless epoxy<sup>250</sup> or sheet vinyl flooring with an integral cove base. Metal or plastic strips should not be applied at the top edge of the base.

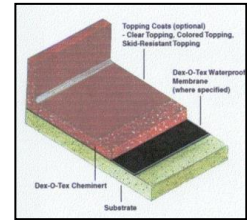

- B. **Walls** – Impact- and/or abrasion-resistant gypsum board<sup>230</sup> installed on minimum 20-gauge metal studs spaced no more than 16 inches on center; paint finish preferred. Sound-attenuating gypsum board<sup>232</sup> may also be used on walls if approved by the manufacturer for use in behavioral health applications.

- C. **Ceiling** – Non-accessible solid gypsum board (sound-attenuating if desired), painted. Provide key-lockable access panels<sup>50</sup> at all patient-accessible locations. If these access panels do not fit tightly or are a larger size, it may be necessary to provide tamper-resistant screws in the corners or along the sides of the panels.

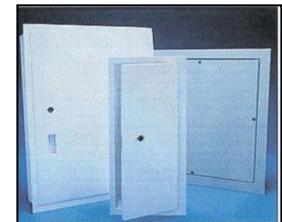

- D. **Doors** – Patient room-to-corridor doors may present an opportunity for patients to barricade themselves in their rooms to delay staff members' access. One solution is to hinge the door so it swings into the corridor, (although this may create its own problem with the *Life Safety Code* and other building codes. As well, this arrangement may (depending on the design) result in creation of an alcove that is difficult to observe and that patients may use as a hiding place from which to attack staff or other patients.

To avoid these problems, patient room-to-corridor doors may be mounted to swing into patient rooms using several other barricade solutions:

1. Double-acting continuous hinges<sup>113</sup> can be used on patient room-to-corridor doors to counteract barricading without the hazard presented by pivot hinges. These continuous hinges are available with a full-height emergency stop<sup>115</sup> that locks in place and can be easily unlocked to allow the door to swing into the corridor.

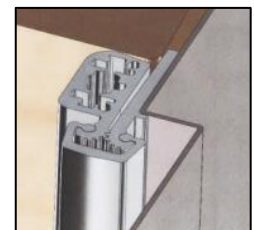
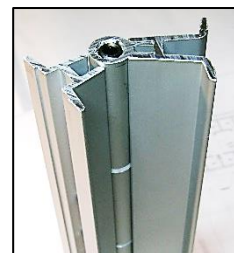

2. The door-within-a-door<sup>44</sup> (sometimes referred to as a “wicket” door) has a portion of the center of the door hinged to swing into the corridor. This hinged panel is mounted on a continuous (or concealed) hinge and secured with a deadbolt lock.



3. If space is available, a separate narrow (18”–24” wide) door that swings into the corridor may be used for emergency access to the room. This smaller leaf can either be mounted in the same frame as the main door in a “double-egress” configuration or there can be a mullion<sup>47</sup> between the two leaves.



4. The top of all tight-fitting doors provides a pinch point that allows a patient to tie a knot (in a sheet, the leg of a pair of jeans, or other object), place it over the top of the door, and close the door to create a hanging device. One way to reduce this risk is with a pressure-sensitive or photoelectric device placed near the top of the door that can sound an alarm<sup>150</sup> when activated.

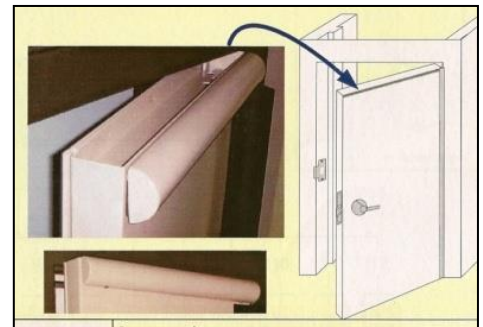
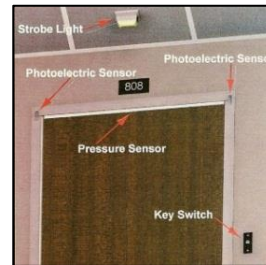

5. Some facilities have begun to address the desire of some patients to lock themselves in their rooms to avoid unwanted entrance by other patients. The challenges with this are to provide individual security for the patient without restricting staff access to the room. Options include locksets with specialized locking functions and ligature-resistant turnpieces<sup>140</sup> that cannot be held from inside the door to resist a key being turned to unlock the door. A cylinder protector<sup>141</sup> to cover the lock cylinder on the corridor side of the door resists attempts to insert objects in the keyway. Card access technology is also available to control these locks.

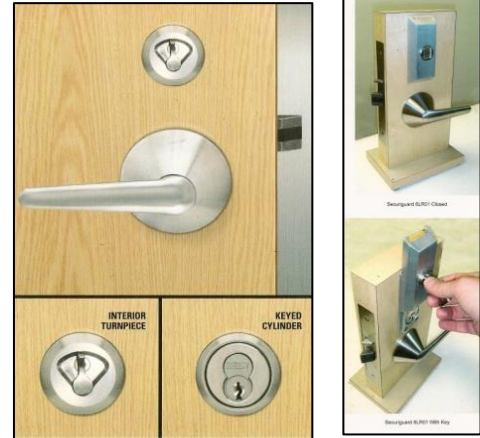

## E. Glass

1. **Exterior Windows** – See Level II-D-1 (Safety Glazing) and K. (Operable Windows).

Advances in different types of safety glass make it worthwhile to consult an expert for advice for a specific project. The height above the ground, patient population, and many other factors should be taken into account in choosing these materials. Comply with all applicable codes and regulations for operable sash.

2. **Security Screens** - If replacing windows presents a prohibitive cost in remodeling work, a security screen with a very sturdy steel frame<sup>80</sup> designed to resist deflection and equipped with multiple key locks and a heavy-gauge stainless steel screen fabric<sup>81</sup> may be used. These are functional and secure, but create an “institutional” appearance and can be defaced by writing obscene words with toothpaste (or other material).

3. **Mirrors** – Radiused stainless steel-framed security mirrors<sup>360</sup> are preferred for patient room mirrors. The reflective surface may be polycarbonate, tempered glass, stainless steel, or chrome-plated steel. Each has durability and distortion characteristics. Some framed mirrors have a flat surface on top and/or do not fit tightly to the wall and provide opportunities for ligature attachment. Where this occurs, a tapered strip<sup>361</sup> may be installed to reduce this ligature risk.

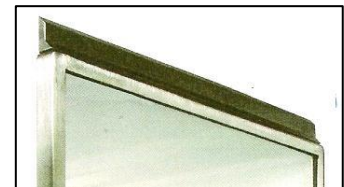

4. **View Windows to Corridors** – Use of polycarbonate,<sup>201</sup> security glazing, or tempered glass is recommended for view windows to corridors in doors and sidelights. If a fire rating is required by code, fire-rated glass should be provided. Wire glass is no longer allowed by most codes and jurisdictions.

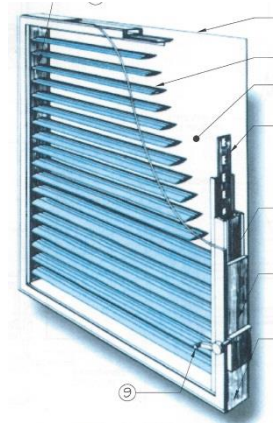

Use of view windows in patient room-to-corridor doors or sidelights brings up some conflicting issues. One point of view is that they are necessary to allow staff observation, while others believe the windows infringe on patient privacy because anyone, including other patients, can see into the room. One solution is to provide an operable blind<sup>220</sup> that only staff can control from the corridor side.

**F. Hardware** – See comments under Level II-E.

It is highly desirable to keep vacant patient rooms locked at all times to prevent other patients from entering these rooms without staff knowledge. However, because many jurisdictions do not permit provision of means to lock a patient in a room, “classroom”-type locks are recommended. These can always be opened from the inside, and the corridor side may be either locked or unlocked with a key.

**G. Light Fixtures** – Same as in Level II except that all light fixtures should be security-type fixtures.<sup>620</sup>

Advancements in LED lighting applications are rapidly creating new options. The use of traditional 2’x4’ fluorescent light fixtures creates a very commercial or institutional appearance in patient rooms, and the placement of one of these directly over the bed is a carryover from general hospital design that is seldom needed in behavioral health facilities. Preference is for using either round or oval surface-mounted, vandal-resistant fixtures for general illumination and recessed security downlights with polycarbonate lenses over the beds for reading lights. Many of these fixtures are now available with LED light sources.

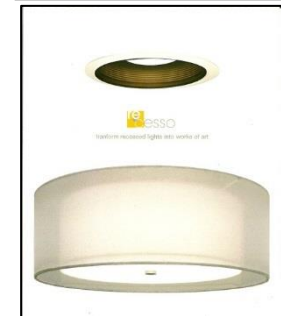

Covers<sup>630</sup> are available for existing (or new) downlights that are secure and make the appearance more residential in nature.

No glass components should be exposed to patients in any fixture, and use of table lamps and desk lamps is strongly discouraged.



## H. Fire Sprinklers, Institutional Type – Same as for corridors in Level II.

## I. HVAC Grilles and Equipment

1. Fully recessed vandal-resistant grilles with S-shaped air passageways<sup>602</sup> are recommended for all ceiling and wall-mounted grilles.
2. In new construction or major remodeling projects, locate individual room HVAC equipment (such as fan/coil units) in an adjacent corridor or another location (e.g., an interstitial space) where they can be serviced without entering the patient room.
3. In existing facilities that have units located below the windows, manufactured vandal-resistant enclosures<sup>606</sup> should be provided or care should be taken to secure all access panels with tamper-resistant screws. All supply and return air grilles should also be covered with perforated grilles or stainless-steel screen fabric.

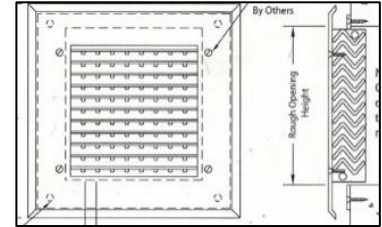

## J. Window-Covering Hardware – Same as for counseling and interview rooms in Level II

## K. Furniture

1. **Furniture** – Sturdy wood, thermoplastic, or composite furniture should be bolted to the floor or walls whenever possible. Care must be taken to assure the furniture will withstand abuse, will not provide opportunities for hiding contraband, does not have joints that will allow penetration of liquids such as urine, and will resist being disassembled to provide patients with weapons.

Open-front units with fixed shelves and no doors or drawers<sup>495</sup> are recommended. Doors should not be provided because they can be used by patients to hang themselves. Drawers should not be provided because they can be removed by patients and broken to use as weapons. All upholstery and foam used in furniture and mattresses should have flame-spread ratings that comply with the requirements of NFPA 101: *Life Safety Code*, Section 10.3.

Desk chairs are preferred to be lightweight<sup>481</sup> or ballasted<sup>480</sup> as discussed in Level III-J (Furniture).

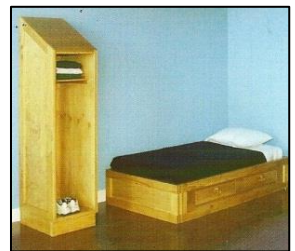
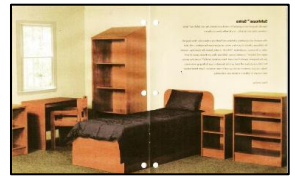

## 2. Beds

a. **Non-Adjustable Platform Beds**<sup>493</sup> – Beds without wire springs or storage drawers are preferred. These beds should be securely anchored in place to prevent patients from using them to barricade the door. If a portable lifting device will be used, beds are available with an opening underneath to accommodate the legs of the lift.<sup>494</sup> Portable lifts can also be accommodated by placing an existing platform bed on a specially designed riser; this arrangement also reduces the amount of bending over staff need to do to work with the patient.<sup>494b</sup>



b. **Mattresses for Platform Beds**<sup>492</sup> – These should be specifically designed for use in behavioral health facilities and be resistant to abuse and contamination.



c. **Manual Hospital Beds** – Where hospital beds are medically necessary, manual hospital beds<sup>491</sup> are preferred. The wheels of these beds should be removed or rendered inoperable to reduce the opportunity of using a bed to barricade the door. It should be noted that the bed rails, headboard, and footboard all present hazards for behavioral health patients.



d. **Electric Hospital Beds** – If electrically operable beds are needed to reduce risk of staff injuries (especially for patients with co-existing medical issues), beds that are specifically suited for use on behavioral health units<sup>490</sup> should be used rather than standard electrically adjustable hospital beds. These specialty beds will sense obstructions and reverse direction and have lockout features for the controls, reduced-length cords, and other tamper-resistant features.



If existing electrically operable beds must be used for financial reasons, use only beds that require a constant pressure on a switch located on the bed rail (not a remote control device or paddle that can be placed on the floor). Also, provide a key lockout switch on the beds (or a removable pigtail) so only staff can operate the beds. All electrical cords should be secured and shortened. Use of a keyed lockout switch is preferred.<sup>611</sup>

As for other wheeled beds, the wheels of electric hospital-type beds should be removed or rendered inoperable and the hazards presented to behavioral health patients by bed rails, headboard, and footboard should be considered.

3. **Wardrobe** – Wardrobe units should not have doors and should have fixed (non-adjustable) shelves.<sup>495</sup> They should be securely anchored in place and have sloped tops. Wardrobes with clothes poles requiring hangers are discouraged because, although the bar can be made safe, the hangers present serious hazards. It should be noted that starting with the 2010 edition, the FGI *Guidelines* no longer calls for patient rooms to have accommodations for “hanging full-length clothing.” The average length of stay in many facilities is now in the 7- to-10-day range, and patients seldom come with clothing that needs to be hung up.



#### L. Miscellaneous

All requirements for lounges and activity rooms in Level III-L (Miscellaneous) apply to this level also.

1. **Pull Cords** – Nurse call systems are generally not required for behavioral health units. If they are provided, pushbutton-type activation switches<sup>653</sup> are preferred. If cords are provided, it is recommended they be no longer than 4” and as lightweight as possible.
2. **Electrical Receptacles** – In new construction or major remodeling, provide a dedicated circuit for all electrical outlets in each patient room and bath. This will allow power to the outlets in a specific room to be turned off if necessary for a patient’s safety. Where this is not practical, the outlet may be temporarily covered.

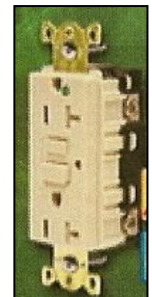

It is strongly recommended that all electrical outlets in patient rooms and patient toilet rooms be a hospital-grade, tamper-resistant type. Use of GFCI receptacles<sup>610</sup> is also preferred to reduce the risk of patients being able to harm themselves by tampering with the receptacles.

All electrical switch and outlet cover plates should be as discussed in Level III.

4. **Coat Hangers** – Use of hangers is not recommended.
5. **Cubicle Curtains and Tracks** – These are not recommended for use in behavioral health facilities because of the risk they present. If non-ambulatory patients with co-existing medical conditions are being treated on these units, it is recommended they be assigned to single-patient rooms.

5. **Telephone** – If desired, cordless phones may be provided to allow patients to check out a phone for private conversations when appropriate. Phones should not be left in patient rooms permanently because they can be used as weapons.
7. **Television Sets** – Typically, televisions should not be provided in patient rooms to encourage patients to use activity areas with other patients, which allows easier supervision. Some facilities that treat behavioral health patients with medical conditions that prevent them from being ambulatory provide television sets in tamper-resistant enclosures<sup>290</sup> in patient rooms; these TVs have override controls for staff use.

8. **Medical Gas Outlets** – These are not normally required for behavioral health units. If there is medical necessity or the outlets are a preexisting condition in remodeling projects, they should be covered with lockable panels<sup>590</sup> or panels attached with tamper-resistant screws. These should be removed only to address the medical needs of the current patient and replaced when that patient is discharged or moved. Special care must be taken in semi-private rooms to assure that access to the medical gases does not present a safety risk to the other patient. Some manufacturers offer lockable covers for outlets.



9. **Trashcans and Liners** – Trashcans and liner requirements listed for counseling and interview rooms in Level II also apply to this level. In choosing trashcans and liners, the potential for patient risk should always be assessed. Plastic liners should be prohibited because of the risk of suffocation. A substitute liner made of paper<sup>1</sup> may be used.

10. **Baseboards** – Use of thin, flexible rubber or vinyl baseboards that are applied only with adhesive and are intended to cover the joint between the wall and floor is strongly discouraged. These become prime targets for patient tampering and can be used to conceal contraband.

Finishing the wall surface to the floor, sealing the joint with pick-resistant sealant,<sup>20</sup> and painting a contrasting color stripe at the floor is preferred. There are several alternatives for locations where finishing the wall material to the floor is not practical:

- a. Seamless epoxy flooring<sup>250</sup> that has an integral covered base is an exception to this as long as there is no metal edge strip on the top of the base.
- b. A pre-molded base<sup>240</sup> that extends onto the floor plane, finishes flush with the top of the floor tile, and is heat-welded to the flooring may be acceptable in

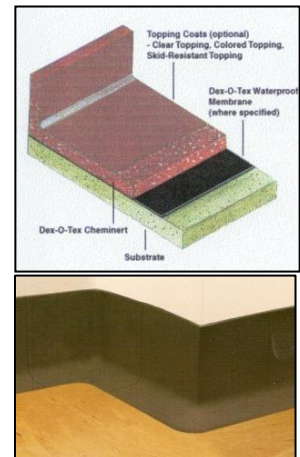



some locations. However, use of this product does not address the issue of hiding contraband unless the top edge is sealed with a pick-resistant sealant.<sup>20</sup>

c. A thick rubber base that resembles wood base profiles<sup>241</sup> is available and provides a more “residential” appearance. All joints to the wall and floor and all vertical joints should be sealed with a pick-resistant sealant.<sup>20</sup>

d. In some cases, a wood base with a minimum  $\frac{3}{4}$ ” thickness that is adhered to the wall, secured with countersunk tamper-resistant fasteners, and sealed with pick-resistant sealant<sup>20</sup> has been used successfully. If desired, this can be given a semi-transparent stain finish to provide more of a residential look.



## Level IV-b. Patient Toilet Rooms

A. **Floors** – Choose one of the following depending on the acuity of the patient population:

1. **Seamless Epoxy Flooring**<sup>250</sup> – This flooring should have a slip-resistant finish and integral cove base and can be used in a shower. Do not use a metal or plastic strip at the top of the base as patients can remove it for use as a weapon.

2. **Ceramic and Porcelain Tile.** Larger tiles may be used (to reduce the number of joints) as long as the installation is maintained in good condition.

3. **One-Piece Floor Units** – These units<sup>566</sup> provide a monolithic floor (European-style) for the entire patient toilet room that drains the shower to a central location. If used in conjunction with location of the shower enclosure and shower head, this unit can eliminate the need for shower curtains.

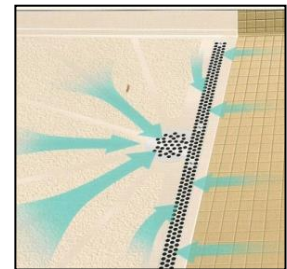

4. **Solid-Surface Material Floors** – These are available with a trench drain<sup>565</sup> across the entire front opening of the stall, which not only helps keep water from getting into the room, but also makes the drain more difficult for patients to intentionally clog. Fiberglass shower stalls and floors are generally not durable enough.

5. **Pre-Built Bathrooms**<sup>568</sup> – These contain all finishes, fixtures, and accessories and can reduce construction time because they are shipped to the site ready to be connected to the utilities.



B. **Walls** - Use one of the following depending on the acuity of the patient population and the project budget:

1. Avonite<sup>320</sup> (without trim pieces) or solid-surface sheet material
2. Ceramic or porcelain tile in large pieces
3. Gypsum board that is impact-resistant and has mold- and moisture-resistant facing<sup>230</sup> with epoxy paint; solid-surface sheets in showers

C. **Ceiling** – Gypsum board with mold- and moisture-resistant facing<sup>230</sup> with epoxy paint is recommended.

D. **Glass** – Mirrors, same as for patient rooms in Level IV

E. **Door** – The first question to address for patient toilet room doors is whether the facility ever has the need/desire to lock patients out of their bathrooms.

1. If there is a need to lock patients out of the bathroom, a full, out-swinging door mounted on a single-acting continuous hinge with hospital tip and over-door alarm<sup>150</sup> will need to be installed. Also, a classroom function deadbolt<sup>144</sup> (with a ligature-resistant turn piece that will retract the bolt but not extend it), two flush pulls<sup>121</sup> mounted back to back, and a roller<sup>146</sup> or ball<sup>145</sup> latch should be installed.

2. If it is not necessary to lock patients out of their bathrooms, one of the following options may be provided:

- a. **Soft Suicide Prevention Door (SSPDoor)**<sup>40b</sup> – This door eliminates many of the hanging hazards associated with a typical door. It is attached with magnets and may be easily removed by staff for use as a shield against an attacking patient. A photograph can be printed on its faces. This door cannot be locked or latched in any manner. (Use of this product eliminates the need for the items listed under “Hardware” below.)



b. **Sentinel Event Reduction Door**<sup>40</sup> – One of these doors without a movable top panel is another option. Privacy for two patient rooms can be improved slightly by installing the door a little higher than normal.

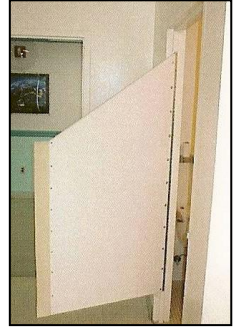

c. Some facilities with single-patient rooms are electing to remove doors entirely from patient toilet rooms. The practicality of this depends on the sight line into the toilet room from the corridor door.

F. **Hardware** - See Section II-E.

G. **Light Fixtures** – Same as patient rooms in Level IV except that fixtures shall be water-resistant with a sealed polycarbonate lens. No glass components should be used in any fixture.

H. **Fire Sprinklers, Institutional Type** – Same as for corridors in Level II

I. **HVAC Grilles and Equipment** – Fully recessed, vandal-resistant grilles with S-shaped air passageways<sup>602</sup>

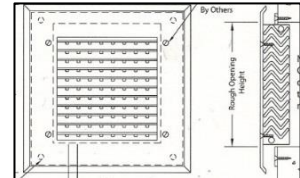

J. **Miscellaneous**

1. **Medicine Cabinets** – These should not be provided because of the difficulty in observing potentially dangerous items that may be placed in them.

2. **Robe Hooks** – Evaluate the risk of using these hooks. If they are required, they should be the collapsible type.<sup>350</sup>



3. **Towel Bars** – Use collapsible hooks<sup>350</sup> instead of towel bars for towels.

4. **Grab Bars** – Because some patients may be on medications that interfere with their equilibrium, grab bars for toilets and showers are recommended for all patient-accessible toilets. A self-draining bar<sup>332</sup> may be installed on a slight slope with one end cap on the higher end. These provide a high degree of safety and are also easy to clean and sanitize. If the wall surface behind the bar is not smooth and flat, provide pick-resistant sealant to the joint between the bar and the wall.

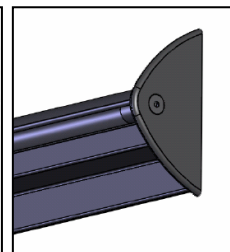
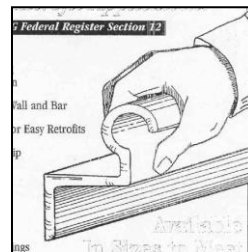

5. **Vertical Grab Bars** – In locations where vertical grab bars are required or desired, typical ligature-resistant bars mounted vertically can usually be grasped only from one side. A ligature-resistant grab bar



Cross-section



Finished End

specifically designed to be mounted vertically<sup>337</sup> can be grasped from either side.

6. **Shower Curtains and Curtain Tracks** – No shower curtains or their tracks of any type (including those designated as “breakaway” and represented by their manufacturers as “safe for psychiatric hospitals”) are recommended for use in any patient-accessible areas, especially patient showers. In new construction, showers could be designed to contain the spray within the compartment without the use of a curtain. In existing facilities, the use of a Soft Suicide Prevention Shower Door<sup>41</sup> or Sentinel event reduction door<sup>40</sup> mounted with a minimal gap between the bottom of the door and the floor may be used for 36-inch or narrower openings. A Sentinel Event Reduction Shower Door<sup>473</sup> with a seal on the bottom may also be provided.



7. **Nurse Call Switches** – Where nurse call switches are required or provided, they should be a ligature-resistant, push-button type.<sup>653</sup> If pull cords are provided, they should be no longer than 4” and as lightweight as possible.

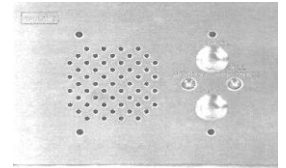

8. **Lavatories** – Typical commercial solid-surface countertops with integral sinks offer a much less institutional appearance. They also provide a place for patients to set their toothbrushes, etc. Specialty vanity top-type lavatories<sup>541</sup> provide many of the same benefits.



9. **Wall-Hung Solid-Surface Lavatories** – These make it very difficult to tie anything around them.<sup>540</sup>

Use of the optional filler panel is recommended to fill the space between the side of the fixture and an adjacent wall when there is one near the fixture. Stainless steel or high-impact polymer pipe covers that fit beneath the unit should also be provided.



If a wall-mounted lavatory is used, a shelf (surface-mounted or recessed)<sup>370</sup> that limits attachment of a ligature may be needed to hold toiletry items.





10. **Lavatory and Sink Faucets and Valves** – Faucets and valves can provide attachment points for ligatures. A lavatory valve unit is now available that uses a shower valve fitted with a ligature-resistant handle<sup>574</sup> to allow patients to control the temperature (thermostatically limited to prevent scalding) and duration of the water flow. This valve can be used to replace the motion sensor activation of some faucets. Faucets are available in a variety of materials and configurations that range from push-button to motion sensor-activated.<sup>570</sup>

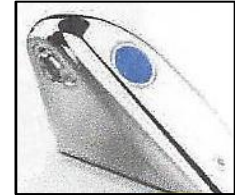

11. **Lavatory Waste and Supply Piping** – All piping of this type must be enclosed so it is not accessible to patients.<sup>410</sup> Extreme care should be taken to trim the enclosing material so it fits tightly to the underside of the lavatory fixture to prevent the patient from using this space to hide contraband.



12. **Soap Dishes**<sup>390</sup> – These should not have handles and should be recessed.



13. **Soap Dispensers** – Many facilities now use liquid or foam soap in patient areas, but the commonly used hard-plastic soap dispensers are problematic in that they are fairly easy to pull off the wall and break into sharp shards that can be used as weapons. At least one manufacturer now offers steel covers for their standard dispensers. Another solution is a dispenser made of solid-surface material<sup>391</sup> commonly used for countertops that is relatively tamper-resistant. Some commercially available stainless steel dispensers are reasonably ligature-resistant.

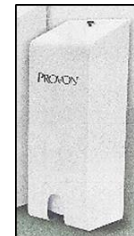

14. **Toilets** – Toilets used by behavioral health patients should be a floor-mounted, back outlet, back water supply type<sup>530</sup> rather than a wall-mounted fixture, which can be broken off its hangers. Currently, the only china fixtures in this configuration are ADA handicapped-accessible fixtures.<sup>531</sup> Where wall-hung toilets exist and replacing them is not practical, a wall-hung toilet support<sup>538</sup> can be used if it can be secured so patients cannot remove it to use as a weapon.



Movable seats provide attachment points for ligatures, so their use should be considered carefully by each hospital. The solution is to use a fixture with an integral seat as suggested above. Some facilities feel this is too prison-like and choose to accept the risk of the movable seat.



China fixtures themselves (both floor- and wall-mounted) can be broken into large, sharp shards. Toilet fixtures made of solid-surface material<sup>533</sup> and stainless steel<sup>534</sup> are available and are much more resistant to breakage. stainless steel fixtures can be powder-coated for a “institutional” appearance.



mounted) fixtures steel<sup>534</sup> are The less

Toilet fixtures that will support loads in excess of 2,500 pounds are available if needed for patients of size.<sup>536</sup>

16. **Toilet Waste Line Clog Removal Assistant** – Patients in behavioral health facilities have been known to attempt to clog toilets with various materials. A product is now available to help simplify removal of material clogging waste lines.<sup>537</sup> This is installed in the waste line immediately adjacent to the fixture and is intended to catch the material at that location, where it can be removed more easily by maintenance staff.



17. **Flush Valves** – Toilet flush valves that are recessed in the wall<sup>580</sup> and activated by a push button<sup>581, 582</sup> are preferred. Where this is not practical, the flush valve and all related pipes should be enclosed with a stainless steel<sup>584</sup> or plastic<sup>584</sup> cover with a sloped top that incorporates a push-button activator for the valve.



## 18. Toilet Paper Holders

- a. A semi-recessed toilet paper holder<sup>400</sup> that does not require a bar or tube to hold the paper allows for safe, standard use of the roll of toilet paper without requiring everyone using the roll to handle it.
- b. Fully recessed<sup>4010</sup> stainless steel tube-type holders have been used widely for years; however, some organizations feel this creates an infection control problem because all users have to handle the entire roll.

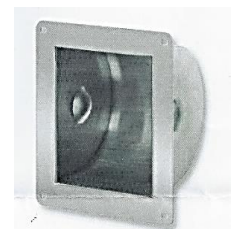

- c. Other toilet paper holders use a bar(s) that pivots down<sup>402</sup> when vertical pressure is imposed.



## 19. Shower Control Valves

*Note:* Provide **thermostatically limited hot water** to prevent accidental or intentional scalding in all patient-accessible toilet rooms.

- a. Single-knob mixing valves that provide minimal opportunity for tying anything around them are preferred.<sup>552</sup> These give patients control of the water temperature and duration of flow. Some of these are claimed to be ADA-compliant by their manufacturers.
- b. If it is only necessary to replace the valve handles and the valve itself is working properly, use of a replacement valve handle<sup>553</sup> that can be adapted to a variety of valves might be considered. *Note:* This may void any remaining warranty on the existing valve.
- c. A “no-touch” valve<sup>551</sup> that appears to be clearly ADA compliant is available. It utilizes infrared controls to give patients control of a range of water temperatures and the duration of flow.



- d. One-piece shower assemblies that contain a shower head, push-button valves, and a recessed soap dish<sup>560</sup> work well for remodeling projects because they reduce the amount of repair needed for wall finishes. These are also available with a second head located 48” above the floor and a diverter valve if needed for ADA purposes.



**20. Shower Heads** – These should be a ligature-resistant institutional type.<sup>550</sup> Handicapped-accessible showers are required to have either a handheld shower head or a second, lower head 48” above the floor. The handheld shower head should be on a ligature-resistant, quick-disconnect fitting that allows removal of the head and attached hose when not in use. If a hook is provided to hold the handheld showerhead, it should be mounted on the part of the fitting that is removed when the hose is removed. Another option is to provide a lockable cabinet to house the handheld head and valve.<sup>563</sup>

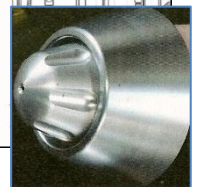
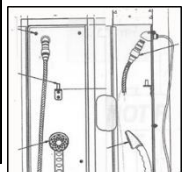

21. **Diverter Valve** – If a diverter valve is needed to change the water flow from the standard shower head to the ADA-required head, a ligature-resistant diverter valve<sup>557</sup> may be provided.

22. **Folding Shower Seats** – Shower seats that fold away typically have many tubes and brackets that are hazardous. If a folding shower seat is necessary, one without the tubes and brackets<sup>380</sup> is suggested.



23. **Shelves** – Shelves to hold miscellaneous items are often requested in shower stalls and near wall-hung lavatories. A stainless steel suicide-resistant shelf that is either surface-mounted or recessed into the wall<sup>370, 371</sup> may be considered for these applications.



24. **Paper Towel Dispensers** – Paper towel dispensers are a concern in patient-accessible toilets because they typically are constructed of light-weight materials that can either be broken or bent to form sharp objects that may be used as weapons. Alternatives are as follows:

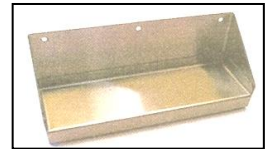

- a. Place a small stack of paper towels on a surface-mounted or recessed shelf.
- b. Provide a heavy-gauge, vandal-resistant dispenser.<sup>340b</sup>
- c. Install a heavy-duty secure cover<sup>340a</sup> over a standard-weight paper towel dispenser.

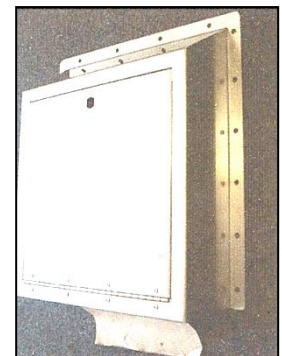

25. **Electrical Receptacles** – Providing ground-fault circuit interrupter (GFCI)-type electrical circuit breakers for all receptacles near sources of water (e.g., lavatories, toilets, and showers) and in all patient-accessible areas is required by the FGI *Guidelines*.



## Level V-a. Admissions

If possible, the admissions function should not take place on an inpatient unit. At admission, unit staff members know very little about a new patient and his or her trigger points. A separate location for admission avoids disrupting either the unit or the new patient due to the agitation of either.

This room should be pleasant and welcoming and should be minimally furnished (with a few loose pieces of furniture).

The room should be large enough to allow for several staff to physically manage the patient if necessary. If possible, the admitting staff member should not be in the room alone with a patient. After the admitting process is complete, the patient can be escorted to the unit. These precautions are particularly important for emergency admissions, which frequently occur at night and on weekends.

A. **Floors** – Same as activity rooms and lounges in Level III

B. **Walls** – Same as patient rooms in Level IV

C. **Ceiling** – Same as patient rooms in Level IV

D. **Glass**

1. Same as in Level IV

2. Provide a small (12"x12" or 4"x24") view window that can be controlled by staff to restrict views into or out of this room.

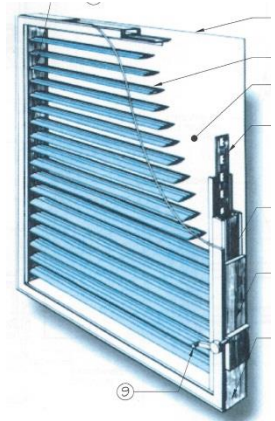

E. **Hardware** – Same as in Level IV

F. **Light fixtures** – Same as in Level IV

G. **Fire Sprinklers, Institutional Type** – Same as in Level IV

H. **HVAC Grilles** – Fully recessed, vandal-resistant grilles with S-shaped air passageways<sup>602</sup>

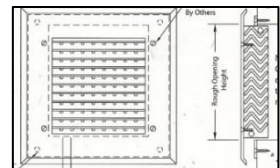

I. **Window Covering Hardware** – Same as in Level IV

J. **Miscellaneous**

1. All miscellaneous requirements listed for corridors in Level II also apply to this level.

2. An emergency call button for use by staff should be provided so staff may summon additional staff members if necessary.

3. Baseboards same as patient rooms in Level IV

## K. Furniture

1. This room should have a built-in desk or table that is firmly attached to the floor or walls and contains a lockable file drawer for forms and a lockable box drawer for pens, pencils, staplers, etc. All loose items should be kept in drawers and out of sight. The furniture arrangement should locate the patient chair so the patient, when seated, will not be between the staff member and the door to the room.
2. The computer, printer, and telephone should be located so the patient cannot easily reach them. The use of tablet computers and cordless phones in these rooms is preferable.
3. Seating should be fixed in place or heavyweight as discussed in Level II-M (Furniture).

## Level V-b. Seclusion Rooms

Seclusion rooms are required by the FGI *Guidelines* to be no less than 7 feet wide and no greater than 11 feet long to avoid providing enough space for a patient to get a running start at the opposite wall. They should be designed to minimize blind spots where patients cannot be observed by staff without entering the room. A minimum ceiling height of 9 feet is preferred. The distance of the seclusion room from the nurse station needs to be considered. The goal is to avoid excessive distance so staff can be readily available as needed. The seclusion room door should open directly into an anteroom to separate these activities from other patients and give the patient access to a toilet without entering the corridor.



A. **Floor** – Continuous sheet vinyl with foam backing and heat-welded seams<sup>272</sup> or padded flooring to match wall padding, if used

B. **Walls** – Impact-resistant gypsum board<sup>230</sup> over 3/4” plywood on 20-gauge metal studs at 16” on center with high performance finish.<sup>280</sup> If wall padding is desired, use of systems with Kevlar-facing or heavy vinyl facing with a 1 1/2” thick foam backing<sup>270</sup> may be considered.

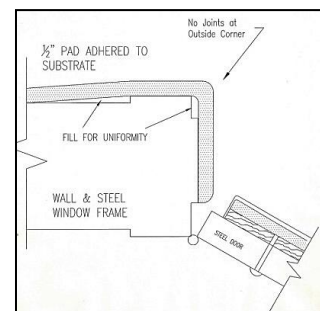

One facility has encountered issues with authorities having jurisdiction when using plywood for this purpose and has substituted 25-gauge sheet metal, which stiffens the wall, is easily cut and does not require wider door frames.

C. **Ceiling** – Impact-resistant and/or abrasion-resistant gypsum board<sup>230, 231</sup> painted at 9'-0” minimum height.



D. **Glass** – All glazing exposed to patients should be the same as in Level II-D. This includes the exterior pane of any window accessible to patients from exterior courtyards.

E. **Hardware**

1. **Doors** – Heavy-duty, commercial-grade steel doors with a minimum clear width of 3'-8" that are hinged to open out of the room with a polycarbonate<sup>201</sup> view window not to exceed 100 square inches should be used. The window should be installed at a height that allows shorter staff members to see into the room.

2. **Door Hardware** – Exposed door hardware is typically not provided inside these rooms.

The anteroom side of the seclusion room door shall have three-point latching, which may be individual bolts<sup>162</sup> or one piece of hardware with a single lever to operate all three bolts.<sup>160</sup> Consideration should be given to whether the behavioral health organization wants to have hardware that latches immediately when the door is closed or hardware that requires manual motion to latch the door. A self-latching door may increase the risk of staff becoming locked in the room with a patient, and a keyed cylinder (or concealed card reader) may need to be accessible from inside the room.



F. **Light Fixtures** – Fully recessed, moisture-resistant, vandal-resistant light fixtures<sup>620</sup> installed in the ceiling are recommended.

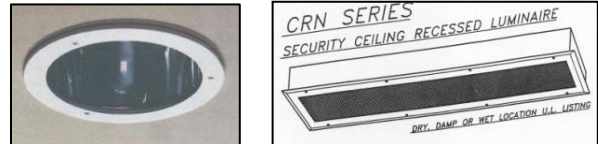

G. **Fire Sprinklers, Institutional Type** – Same as for Level IV



H. **HVAC grilles**

1. Fully recessed, vandal-resistant grilles with S-shaped air passageways<sup>602</sup>
2. **Thermostats** – These should be a digital type with control mounted on the wall in the anteroom and sensor in the return air duct serving the room.

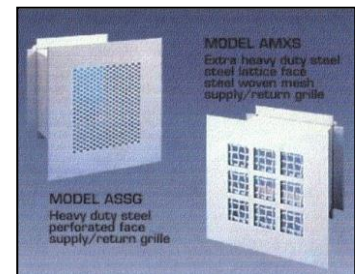

I. **Window Covering** – No window covering material or hardware should be accessible to the patient. All window coverings should be behind safety glazing as described in Level II-D. Mini-blinds, roller shades, or other types of window covering may be used behind the safety glazing as long as only staff can operate them and no ligature attachment points are provided by the system. If electrically operated devices are chosen, controls should be located in the anteroom.

## J. Miscellaneous

1. No electrical outlets, switches, thermostats, blank cover plates, or similar devices are permitted inside seclusion rooms.

2. **Toilets** – Same as those in Level IV-B. Powder-coated stainless steel fixtures are preferred for some facilities.



3. No baseboards should be used in these rooms.

4. **Observation Mirror** – Install a convex mirror like that required for glass in corridors in Level II-K-9 (Observation Mirrors). Locate the mirror in the upper corner of the room opposite the seclusion room door. Make sure the mirror can be seen when viewing it from the window in the door. This mirror will give staff a 360-degree view of the room prior to opening the door. Care shall be taken to assure the attachment is secure so the patient cannot remove it and have a weapon.

K. **Furniture** – A seclusion room should have only a behavioral health care mattress<sup>492</sup> on the floor or a special seclusion room bed.<sup>493a, 498</sup> These beds are available with loops to which mechanical restraints may be attached, if needed.

## SUMMARY

Thoughtful consideration of these design elements and materials by design team members and hospital staff can result in a very aesthetically pleasing environment that will enhance the treatment process and help maximize safety for patients, staff, and visitors. It is strongly recommended that wall-hung lavatories, 2'x4' fluorescent light fixtures, paddle-handle door hardware, and many other items typically found in general hospitals **NOT** be used in behavioral health facilities. The reasons these are used in general hospitals typically do not exist in behavioral health care units. Their elimination will significantly reduce the institutional character of behavioral health facilities without decreasing patient or staff safety. As stated in the introduction, this document is intended to represent best current practices, in the opinion of the authors, and does not establish minimum standards for behavioral health facilities.

## APPENDIX

### 1a. Trash can liner – paper

#### **Sani-Liner®**

Wisconsin Converting  
1689 Morrow Street  
Green Bay, WI 54302  
920-593-8297

[www.wisconsinconverting.com](http://www.wisconsinconverting.com)

### 1b. Trash can liner – paper

#### **851-S36 SR™ Breathable Trash Can Liners**

Weizel Security  
800-308-3627

[www.securingshospitals.com](http://www.securingshospitals.com)



### 1c. Trash can liner – paper

#### **Psych-Select-Bag™**

Dano Group  
150 Harvard Avenue  
Stamford, CT 06902  
800-348-3266

[www.danoinc.com](http://www.danoinc.com)



### 10. Sound and smoke/fire seals – breakaway

#### **Cush 'N' Seal with breakaway anti-ligature option**

Door and Hardware Systems, Inc.  
17 Silver Street  
Rochester, NY 14611  
585-235-8543

[www.dhsi-seal.com/](http://www.dhsi-seal.com/)

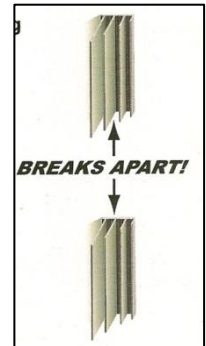

### 20a. Pick-resistant caulk

#### **Dynaflex™ SC**

Pecora Corporation  
165 Wambold Road  
Harleysville, PA 19438  
800-523-6688

[www.pecora.com](http://www.pecora.com)

Product information included in this document is intended for illustration of one or more specific items that are deemed appropriate for use in this type of facility. Comparable products by other manufacturers that meet the same design criteria may be substituted after careful comparison.

## 20b. Pick-resistant caulk

**SB-190 Everseal**

Surebond  
3925 Stern Avenue  
St. Charles, IL 60174  
877-843-1818  
[www.surebond.com](http://www.surebond.com)



## 20c. Pick-resistant caulk

**Mastereal® CR 190**

BASF Construction Chemicals  
889 Valley Park Drive  
Shakopee, MN 55379  
800-243-6739  
[www.master-builders-solutions.basf.us](http://www.master-builders-solutions.basf.us)

## 25a. Synthetic faced door

**C/S Acrovyn® Doors**

Construction Specialties  
3 Werner Way  
Lebanon, NJ 08833  
800-972-7214  
[www.c-sgroup.com](http://www.c-sgroup.com)



## 25b. Synthetic-faced door

**Thermal-Fused Doors**

ASSA ABLOY Door Group  
c/o Maiman  
3839 East Mustard Way  
Springfield, MO 65803  
417-616-8234  
[www.assaabloywooddoors.com](http://www.assaabloywooddoors.com)



## 30. Quick-release hinge door

**Quick-Release Hinge Door**

Total Door Systems  
6145 Delfield Dr.  
Waterford, MI 48329  
248-623-6899  
[www.total-door.com](http://www.total-door.com)



Product information included in this document is intended for illustration of one or more specific items that are deemed appropriate for use in this type of facility. Comparable products by other manufacturers that meet the same design criteria may be substituted after careful comparison.

## 40a. Patient toilet door

**Sentinel Event Reduction Door**

Norva Plastics, Inc.  
 3911 Killam Ave.  
 Norfolk, VA 23508  
 800-826-0758  
[www.norvaplastics.com](http://www.norvaplastics.com)



## 40b. Patient toilet door

**Soft Suicide Prevention Door**

Kennon Products, Inc.  
 2071 North Main Street  
 Sheridan, WY 82801  
 307-674-6498  
[www.suicideproofing.com](http://www.suicideproofing.com)



## 40e. Patient shower door

**Suicide-Resistant Shower Door**

Norva Plastics, Inc.  
 3911 Killam Ave.  
 Norfolk, VA 23508  
 800-826-0758  
[www.norvaplastics.com](http://www.norvaplastics.com)



## 44b. Wicket doors

**C/S Acrovyn® Barrier-Resistant Doors**

Construction Specialties  
 3 Werner Way  
 Lebanon, NJ 08833  
 800-972-7214  
[www.c-sgroup.com](http://www.c-sgroup.com)



Product information included in this document is intended for illustration of one or more specific items that are deemed appropriate for use in this type of facility. Comparable products by other manufacturers that meet the same design criteria may be substituted after careful comparison.

## 44c. Wicket doors

**Patient Room Access Door**

Ceco Door  
 9159 Telecom Drive  
 Milan, TN 38358  
 888-264-7474  
[www.cecodoor.com](http://www.cecodoor.com)



## 44d. Wicket doors

**Wicket Door (Wood Doors)**

Marshfield Door Systems  
 1401 East Fourth Street  
 Marshfield, WI 54449  
 800-869-3667  
[www.marshfielddoors.com](http://www.marshfielddoors.com)

## 44e. Wicket doors

**GCD-EC Flush Wicket Door with structural composite lumber core**

Graham Wood Door  
 525 9th St. SE  
 Mason City, Iowa 50401  
 641-423-2444  
[www.grahamdoors.com](http://www.grahamdoors.com)

## 47a. Security sidelight

**Security Sidelite Unit**

Curries Company  
 1502 12th St. NW  
 Mason City, IA 50401  
 641-423-1334  
[www.curries.com](http://www.curries.com)



Product information included in this document is intended for illustration of one or more specific items that are deemed appropriate for use in this type of facility. Comparable products by other manufacturers that meet the same design criteria may be substituted after careful comparison.



## 47b. Security sidelight

**Security SideLite Unit**

Ceco Door  
 9159 Telecom Drive  
 Milan, TN 38358  
[www.cecodoor.com](http://www.cecodoor.com)



## 50. Access panel – lockable

**SP Steel Security Panel with mortise deadbolt prep**

J. L. Industries, Inc.  
 4450 West 78th Street Circle  
 Bloomington, MN 55435  
 800-554-6077  
[www.jlindustries.com](http://www.jlindustries.com)

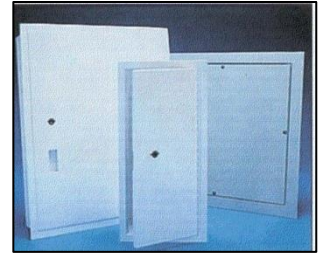

## 430a. Aluminum window with integral blind

**2450 Series Storefront with hinged sash and integral blind**

Manko Window Systems, Inc.  
 800 Hayes Drive  
 Manhattan, KS 66502  
 800-642-1488  
[www.mankowindows.com](http://www.mankowindows.com)

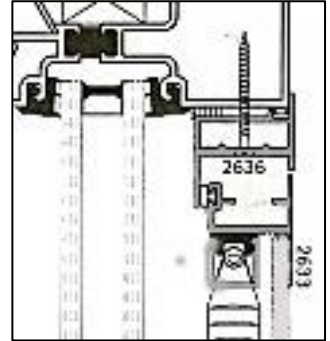

## 430b. Aluminum window with integral blind

**2187-DT Psychiatric Windows with integral blind**

Wausau Window and Wall Systems  
 7800 International Drive  
 Wausau, WI 54401  
 877-678-2983  
[www.wausauwindow.com](http://www.wausauwindow.com)

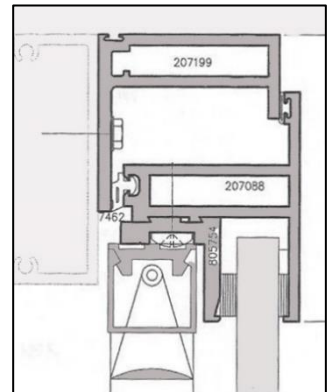

Product information included in this document is intended for illustration of one or more specific items that are deemed appropriate for use in this type of facility. Comparable products by other manufacturers that meet the same design criteria may be substituted after careful comparison.

430c. Aluminum window with integral blind - removable  
**SS-5100 Medium-Security Mental Health Security Window**

Sherwood Windows Group  
 37 Iron Street  
 Toronto, Ontario M9W 5E3  
 Canada  
 800-770-5256  
[www.sherwoodwindows.com](http://www.sherwoodwindows.com)

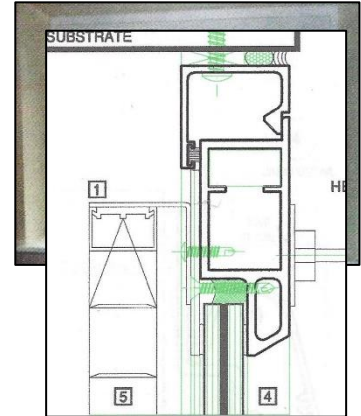

434a. Exterior windows - ventilation

**Safevent Windows**

Britplas  
 Unit 18 Kingsland Grange  
 Woolston, Warrington WA1 4RW  
 England  
 +44-1925-824317  
[www.britplas.com](http://www.britplas.com)

434b. Exterior windows - ventilation

**SW-6300 Operable Security Window**

Sherwood Windows Group  
 37 Iron Street  
 Toronto, Ontario M9W 5E3  
 Canada  
 800-770-5256  
[www.sherwoodwindows.com](http://www.sherwoodwindows.com)



Product information included in this document is intended for illustration of one or more specific items that are deemed appropriate for use in this type of facility. Comparable products by other manufacturers that meet the same design criteria may be substituted after careful comparison.

## 434c. Exterior windows - ventilation

**512 Ventrow Ventilator**

Kawneer North America  
 Technology Park / Atlanta  
 555 Guthridge Court  
 Norcross, GA 30092  
 770-449-5555  
[www.kawneer.com](http://www.kawneer.com)

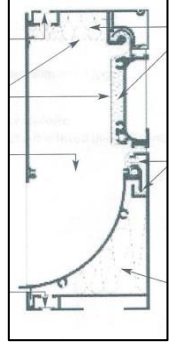

## 80. Security screens

**Security Screens**

Kane Innovations  
 2250 Powell Avenue  
 Erie, PA 16506  
 800-773-2439  
[www.kanescreens.com](http://www.kanescreens.com)

## 81. Stainless steel screen fabric

**Type 304 Stainless Steel Woven Wire Cloth – standard grade**

McMaster-Carr  
 P.O. Box 4355  
 Chicago, IL 60680-4355  
 630-833-0300  
[www.mcmaster.com](http://www.mcmaster.com)

## 100. Security arm door closers

**4510T SMOOTHIE® Series high-security track closer**

LCN  
 121 West Railroad Avenue  
 P.O. Box 100  
 Princeton, IL 61356-0100  
 877-671-7011  
<http://us.allegion.com/brands/lcn/Pages/default.aspx>

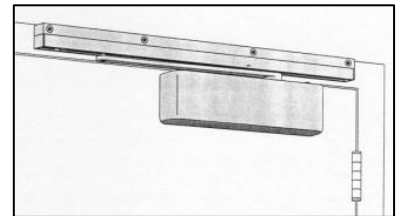

Product information included in this document is intended for illustration of one or more specific items that are deemed appropriate for use in this type of facility. Comparable products by other manufacturers that meet the same design criteria may be substituted after careful comparison.

101. Electrically controlled closer

***Fire/Life Safety Series HSA Sentronic Electrically Controlled Closer/Holder***

LCN

121 West Railroad Avenue

P.O. Box 100

Princeton, IL. 61356-0100

815-875-3111

<http://us.allegion.com/brands/lcn/Pages/default.aspx>

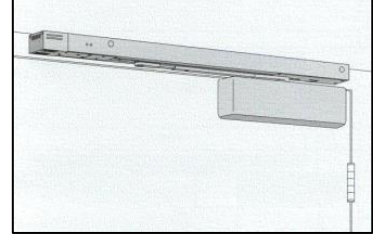

108. Concealed electric power transfer device

***Concealed Electrical Power Transfer (CEPT)***

Securitron USA

10027 South 51st Street, Ste. 102

Phoenix, AZ 85044

800-624-5625

[www.securitron.com](http://www.securitron.com)

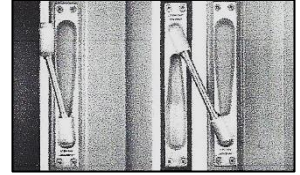

109. Electric-release concealed deadbolts

***ELECTRA™ concealed vertical rod latching lever locksets***

Securitech Group, Inc.

54-60 46th Street

Maspeth, NY 11378

800-622-5625

[www.securitech.com](http://www.securitech.com)

110. Electromagnetic lock

***3000 Series Electromagnetic Locks***

DynaLock Corporation

705 Emmett Street

Bristol, CT 06010

877-396-2562

[www.dynalock.com](http://www.dynalock.com)



- 111a. Continuous hinges – gear type with hospital tip

***780-Series Roton Hinges***

Hager Companies

139 Victor Street

St. Louis, MO 63104

800-325-9995

[www.hagerco.com/Product-Listing.aspx?CatID=152&SubCatID=189](http://www.hagerco.com/Product-Listing.aspx?CatID=152&SubCatID=189)

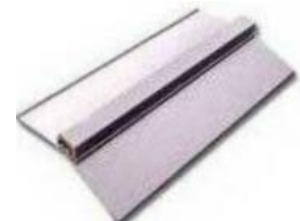

Product information included in this document is intended for illustration of one or more specific items that are deemed appropriate for use in this type of facility. Comparable products by other manufacturers that meet the same design criteria may be substituted after careful comparison.

111b. Continuous hinges – gear type with hospital tip

**112HD Concealed Continuous Hinge**

Ives  
2720 Tobey Dr.  
Indianapolis, IN 46219  
877-671-7011  
<http://us.allegion.com>

111c. Continuous hinges – gear type with hospital tip

**825-S22 SR™ SR824-S22 SafeSupport Continuous Gear Hinge**

Weizel Security  
800-308-3627  
[www.securingshospitals.com](http://www.securingshospitals.com)



111d. Continuous hinges – gear type with hospital tip

**Continuous Gear Hinge with hospital tip, mortise mount – DH430**

Behavioral Safety Products  
29A N. Main St., Suite 3  
Watkinsville, GA 30677  
706-705-1500  
[www.besafepro.com](http://www.besafepro.com)



111e. Continuous hinges – gear type with hospital tip

**LG200 Logica Continuous Geared Hinge**

Kingsway Group USA  
2807 Samoset Road, Suite 200  
Royal Oak, MI 48073  
800-783-7980  
[www.kingswaygroupusa.com](http://www.kingswaygroupusa.com)



113a. Double-acting continuous hinge

**Double Swing Hinge – DSH1000 Barrel Type**

Markar  
P. O. Box 18966  
Memphis, TN 38181

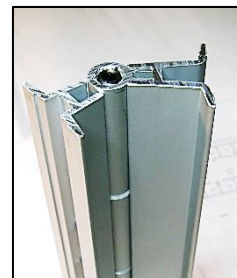

<https://www.assaabloydooraccessories.us/en/local/assaabloydooraccessories/products/hinges/continuous-pin-barrel-hinges/behavioral-health-hinges/>

Product information included in this document is intended for illustration of one or more specific items that are deemed appropriate for use in this type of facility. Comparable products by other manufacturers that meet the same design criteria may be substituted after careful comparison.

## 113c. Double-acting continuous hinge

**LG202 Swing Hinge**

Kingsway Group USA  
 2807 Samoset Road  
 Royal Oak, MI 48073  
 800-783-7980

[www.kingswaygroupusa.com](http://www.kingswaygroupusa.com)

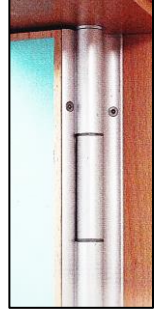

## 115b. Emergency stop

**Emergency Release Stop - ERS**

Pemko Manufacturing Company  
 5535 Distribution Drive  
 Memphis, TN 38141  
 800-824-3018

[www.pemko.com](http://www.pemko.com)

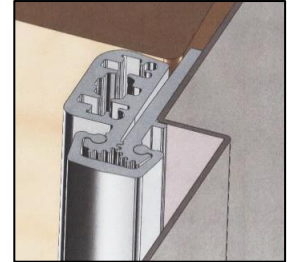

## 115c. Emergency stop

**LG205, LG206 Swing Stop**

Kingsway Group USA  
 2807 Samoset Road  
 Royal Oak, MI 48073  
 800-783-7980

[www.kingswaygroupusa.com](http://www.kingswaygroupusa.com)



## 115d. Swing-through strike plate

**LG149 Swing-Thru Strike Plate**

Kingsway Group USA  
 2807 Samoset Road, Suite 200  
 Royal Oak, MI 48073  
 800-783-7980

[www.kingswaygroupusa.com](http://www.kingswaygroupusa.com)

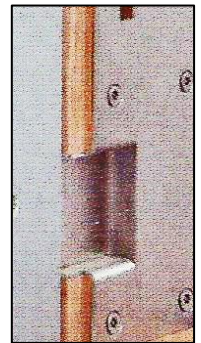

Product information included in this document is intended for illustration of one or more specific items that are deemed appropriate for use in this type of facility. Comparable products by other manufacturers that meet the same design criteria may be substituted after careful comparison.



120. Door pull

**VR910-DT Vandal-Resistant Door Pull Trim**

Ives  
2720 Tobey Dr.  
Indianapolis, IN 46219  
877-671-7011  
<http://us.allegion.com>



121c. Door pull, recessed

**D89 Heavy Duty Security Flush Pull**

Rockwood Manufacturing Company  
300 Main Street  
Rockwood, PA 15557  
800-458-2424  
[www.rockwoodmfg.com](http://www.rockwoodmfg.com)



130a. Ligature-resistant lockset

**SPSL Anti Ligature Lockset**

Best Access Systems  
6161 East 75th Street  
Indianapolis, IN 46250  
317-849-2250  
<http://www.bestaccess.com/index.php/products/behavioral-health-products/>

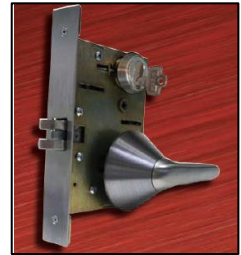

130b. Ligature-resistant lockset

**MRXLGrade 1 Mortise Lock with Ligature-Resistant Escutcheon**

Townsteel, Inc.  
17901 Railroad Street  
City of Industry, CA 91748  
877-858-0888  
[www.townsteel.com](http://www.townsteel.com)



130c. Ligature-resistant lockset

**Schlage L Series Extra Heavy Duty Mortise Lock with ligature resistant lever**

Allegion  
877-671-7011  
<http://us.allegion.com/IRSTDocs/Brochure/106510.pdf>



Product information included in this document is intended for illustration of one or more specific items that are deemed appropriate for use in this type of facility. Comparable products by other manufacturers that meet the same design criteria may be substituted after careful comparison.

130e. Ligature-resistant lockset

**Series 5SS19 Institutional Life Safety Mortise Locksets - Levers**

Marks USA  
365 Bayview Avenue  
Amityville, NY 11701  
800-526-0233  
[www.marksusa.com](http://www.marksusa.com)

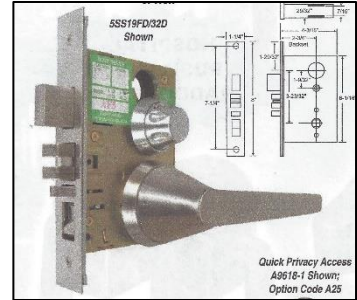

130f. Ligature-resistant lockset

**LSL Life Safety Lever Series**

Grainger  
100 Grainger Parkway  
Lake Forest, IL 60045  
800-472-4643  
[www.grainger.com](http://www.grainger.com)

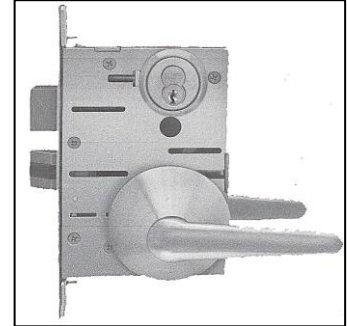

130g. Ligature-resistant lockset

**8200 with BHW Trim**

Sargent Manufacturing Company  
100 Sargent Drive  
P. O. Box 9725  
New Haven, CT 06536-0915  
800-727-5477  
[www.sargentlock.com](http://www.sargentlock.com)



130i. Ligature-resistant lockset

**8200 Mortise Lock with Push/Pull Trim (ALP)**

SARGENT® Manufacturing Company  
100 Sargent Drive  
P. O. Box 9725  
New Haven, CT 06536-0915  
800-727-5477  
[www.sargentlock.com](http://www.sargentlock.com)



130k. Ligature-resistant lockset

**Crescent Handle – horizontal installation**

Accurate Lock and Hardware  
1 Annie Place  
Stamford, CT 06902  
203-348-8865  
[www accuratelockandhardware.com](http://www accuratelockandhardware.com)



Product information included in this document is intended for illustration of one or more specific items that are deemed appropriate for use in this type of facility. Comparable products by other manufacturers that meet the same design criteria may be substituted after careful comparison.

## 130l. Ligature-resistant lockset

**Ligature Resistant Push/Pull 9125ALP**

Accurate Lock and Hardware  
 1 Annie Place  
 Stamford, CT 06902  
 203-348-8865

[www accuratelockandhardware.com](http://www accuratelockandhardware.com)



## 130m. Ligature-resistant lockset

**HD Ligature Resistant Cylindrical Lock CH-CYL Series**

Accurate Lock and Hardware  
 1 Annie Place  
 Stamford, CT 06902  
 203-348-8865

[www accuratelockandhardware.com](http://www accuratelockandhardware.com)

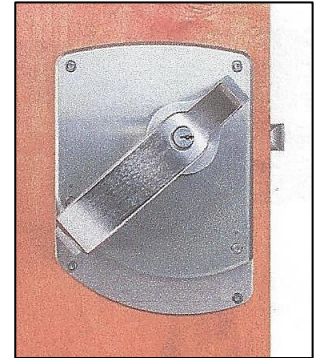

## 140. Patient room privacy lockset

**Patient Room Privacy Lockset**

Best Access Systems  
 6161 East 75th Street  
 Indianapolis, IN 46250  
 800-392-5209

<http://www.bestaccess.com/products/behavioral-health-products/>



## 141a. Cylinder protector

**Securiguard Cylinder Protector; Model #63LR**

Securitech Group, Inc.  
 54-60 46th Street  
 Maspeth, NY 11378  
 800-622-5625

<http://www.securitech.com/securiguard/>



Product information included in this document is intended for illustration of one or more specific items that are deemed appropriate for use in this type of facility. Comparable products by other manufacturers that meet the same design criteria may be substituted after careful comparison.

## 141b. Cylinder protector

**ShieldX Cylinder Protector**

Grainger  
 100 Grainger Parkway  
 Lake Forest, IL 60045  
 800-472-4643  
[www.grainger.com](http://www.grainger.com)

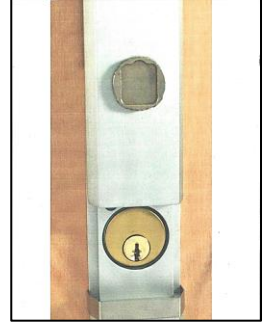

## 143. Deadbolt

**Deadbolt #PBL102-630 with ligature-resistant turn piece (retract bolt only)**

Securitech Group, Inc.  
 54-60 46th Street  
 Maspeth, NY 11378  
 800-622-5625  
[www.securitech.com](http://www.securitech.com)



## 144. Sallyport interlock hardware

**RACHIE™ series lockset package**

Securitech Group, Inc.  
 54-60 46th Street  
 Maspeth, NY 11378  
 800-622-5625  
[www.securitech.com](http://www.securitech.com)

## 146. Remote authorization

**Assa Cliq Remote Authorization System**

Assa Abloy  
[www.assaboly.com](http://www.assaboly.com)

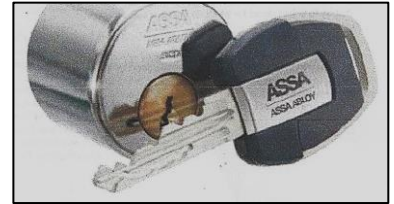

## 146. Ball catch

**347 Dual Adjustable Ball Catch**

Ives  
 2720 Tobey Dr.  
 Indianapolis, IN 46219  
 877-671-7011  
<http://us.allegion.com>



Product information included in this document is intended for illustration of one or more specific items that are deemed appropriate for use in this type of facility. Comparable products by other manufacturers that meet the same design criteria may be substituted after careful comparison.

## 147. Roller latch

**RL30 Roller Latch**

Ives  
 2720 Tobey Dr.  
 Indianapolis, IN 46219  
 877-671-7011  
<http://us.allegion.com>



## 150a. Over-door alarm

**Best; SEDA Door Alarm**

Best Access Solutions, Inc.  
 6161 East 75th Street  
 Indianapolis, IN 46250  
<http://www.bestaccess.com/products/behavioral-health-products/>

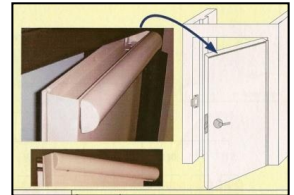

## 150b. Over-door alarm

**The Door Switch**

11772 Westline Industrial Drive  
 St. Louis, MO 63146  
 877-998-5625  
<http://thedoorswitch.com>



## 150c. Over-door alarm

**Top Door Alarm®**

Door Control Services, Inc.  
 321 VZ County Road 4500  
 Ben Wheeler, TX 75754  
 800-356-2025  
[www.doorcontrolservices.com](http://www.doorcontrolservices.com)

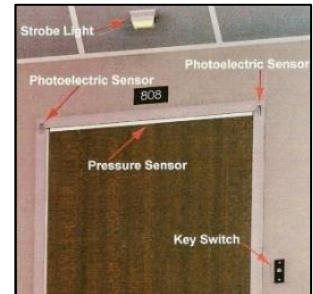

## 150d. Over-door alarm

**LISA-Kit (Life Safety Alarm)**

Grainger  
 100 Grainger Parkway  
 Lake Forest, IL 60045  
 800-472-4643  
[www.grainger.com](http://www.grainger.com)

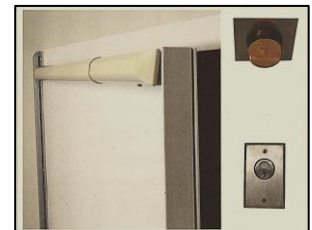

Product information included in this document is intended for illustration of one or more specific items that are deemed appropriate for use in this type of facility. Comparable products by other manufacturers that meet the same design criteria may be substituted after careful comparison.



## 160a. Seclusion room door locks

***Seclusion Room Time-Out Lock (surface mount)***

Securitech  
 54-45 44th Street  
 Maspeth, NY 11378  
 800-622-5625  
[www.securitech.com](http://www.securitech.com)



## 160b. Seclusion room door locks

***Multi-Point Deadbolt Mortise Lock (concealed mount)***

Securitech  
 54-45 44th Street  
 Maspeth, NY 11378  
 800-622-5625  
[www.securitech.com](http://www.securitech.com)

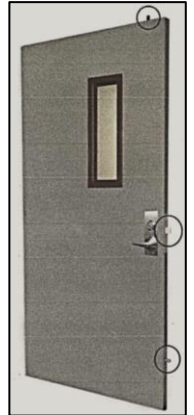

## 160c. Seclusion room door locks

***Schlage; LM9000 Multipoint Solution***

Ingersoll Rand Security Technologies  
 11819 N. Pennsylvania Street  
 Carmel, IN 46032 US  
 877-671-7011  
<http://us.allegion.com/IRSTDocuments1/104833.pdf>



Product information included in this document is intended for illustration of one or more specific items that are deemed appropriate for use in this type of facility. Comparable products by other manufacturers that meet the same design criteria may be substituted after careful comparison.



## 161. Cross-corridor door locks

**#109 Electra Concealed Vertical Rod Latching Lever Locksets**

Securitech  
 54-45 44th Street  
 Maspeth, NY 11378  
 800-622-5625  
[www.securitech.com](http://www.securitech.com)



## 162. Elopement buffer or sallyport door locks

**RACHIE Entry & Exit Control Systems**

Securitech  
 54-45 44th Street  
 Maspeth, NY 11378  
 800-622-5625  
[www.securitech.com](http://www.securitech.com)



## 170. Life safety window hardware

**Sash Control Devices**

Truth Hardware  
 700 West Bridge St.  
 Owatonna, MN 55060  
 800-866-7884  
[www.truth.com](http://www.truth.com)

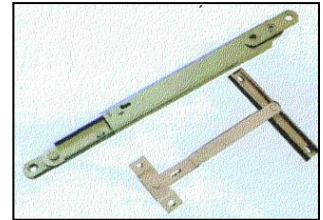

## 190a. Window film

**Scotchshield™ Ultra – 14 mil Ffilm with Attachment System**

3M Specified Construction Products Department  
 3M Center  
 St. Paul, MN 55144  
 888-364-3577  
[www.3m.com](http://www.3m.com)

## 190b. Window film

**200 Series – Safety and Security Laminate**

ACE (Advanced Coatings Engineering)  
 2915 Ogletown Road  
 Newark, DE 19713  
 888-607-0000  
[www.usace.com](http://www.usace.com)

Product information included in this document is intended for illustration of one or more specific items that are deemed appropriate for use in this type of facility. Comparable products by other manufacturers that meet the same design criteria may be substituted after careful comparison.

## 200a. Security glazing

**121000 or 121100 ArmorProtect Plus®**

Oldcastle BuildingEnvelope®  
5005 LBJ Freeway, Suite 1050  
Dallas, TX 75244  
866-653-2278  
[www.obe.com](http://www.obe.com)

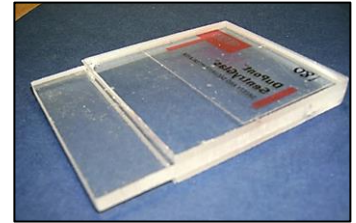

## 200b. Security glazing

**9/16Psych-2118**

Global Security Glazing  
616 Selfield Road  
Selma, AL 36703  
(800) 633-2513  
[www.security-glazing.com](http://www.security-glazing.com)

## 201a. Polycarbonate sheet glazing – abrasion-resistant

**MR10 LEXAN™ MARGARD™ II Sheet**

SABIC Americas  
One Plastics Avenue  
Pittsfield, MA 01201  
800-323-3783  
[www.sabic.com](http://www.sabic.com)

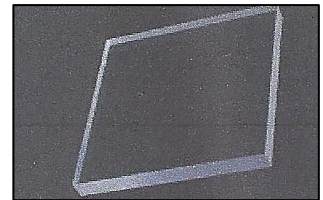

## 201b. Polycarbonate sheet glazing

**Makrolon® GP Sheet**

Covestro LLC  
1 Covestro Circle  
Pittsburgh, PA 15205-9723  
877-229-3778  
[www.sheets.covestro.com](http://www.sheets.covestro.com)

Product information included in this document is intended for illustration of one or more specific items that are deemed appropriate for use in this type of facility. Comparable products by other manufacturers that meet the same design criteria may be substituted after careful comparison.

## 205a. Fire-rated glazing

**SaftiFirst – SuperLite**

O’Keeffe’s, Inc. SaftiFirst  
 100 N. Hill Dr. #12  
 Brisbane, CA 94005  
 888-653-3333  
[www.safti.com](http://www.safti.com)



## 220a. Vision panels

**Vision panels, key operation**

VISTAMATIC®  
 11713 NW 39th Street  
 Coral Springs, FL 33065  
 866-466-9525  
[www.vistamaticvisionpanels.com](http://www.vistamaticvisionpanels.com)

## 220b. Vision panels

**Fixed or motorized louvers inside glass panels**

Unicel Architectural Corp.  
 2155 Fernand Lafontaine Blvd.  
 Longueuil, Quebec, Canada J4G 2J4  
 800-668-1580  
[www.unicelarchitectural.com](http://www.unicelarchitectural.com)

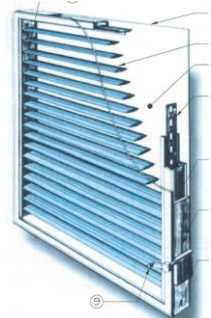

## 220c. Vision panels

**Between Glass Blinds vision panels**

VISTAMATIC, LLC  
 11713 NW 39th Street  
 Coral Springs, FL 33065  
 866-466-9525  
[www.betweenglassblinds.com](http://www.betweenglassblinds.com)

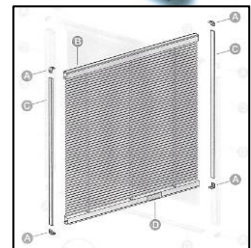

Product information included in this document is intended for illustration of one or more specific items that are deemed appropriate for use in this type of facility. Comparable products by other manufacturers that meet the same design criteria may be substituted after careful comparison.

## 220d. Vision panels

**IE; Blinds® sealed, integral blind assemblies**

IE Blinds  
P.O. Box 442  
Ben Wheeler, TX 75754  
866-267-1917  
[www.ieblinds.com](http://www.ieblinds.com)



## 220e. Vision panels

**Clarity Privacy Glass (electric)**

VISTAMATIC®  
11713 NW 39th Street  
Coral Springs, FL 33065  
866-466-9525  
[www.vistamaticvisionpanels.com](http://www.vistamaticvisionpanels.com)



## 230a. Impact-resistant gypsum board

**Sheetrock® Brand engineered gypsum panels – abuse-resistant**

USG Corporation  
550 West Adams Street  
Chicago, IL 60661  
800-874-4968  
[www.usg.com](http://www.usg.com)

## 230b. Impact-resistant wallboard

**Gold Bond® Brand Hi-Impact® XP® Gypsum Board – moisture- and fire-resistant**

National Gypsum Company  
2001 Rexford Road  
Charlotte, NC 28211  
704-365-7300  
[www.nationalgypsum.com](http://www.nationalgypsum.com)

## 231a. Abrasion-resistant wallboard

**Gold Bond® Brand Hi-Abuse® XP® Gypsum Board**

National Gypsum Company  
2001 Rexford Road  
Charlotte, NC 28211  
704-365-7300  
[www.nationalgypsum.com](http://www.nationalgypsum.com)

Product information included in this document is intended for illustration of one or more specific items that are deemed appropriate for use in this type of facility. Comparable products by other manufacturers that meet the same design criteria may be substituted after careful comparison.

## 232. Sound-absorbing wallboard

**QuietRock sound-reducing panels**

PABCO® Gypsum  
 37851 Cherry Street  
 Newark, CA 94560  
 800-797-8159  
[www.quietrock.com](http://www.quietrock.com)

## 240. Wall base

**Health Design™ Wall Base**

FLEXCO® Corporation  
 1401 East 6th Street  
 Tuscumbia, AL 35674  
 800-633-3151  
[www.flexcofloors.com](http://www.flexcofloors.com)

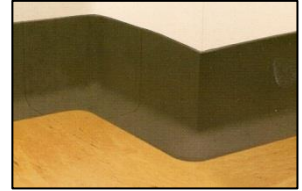

## 241a. Wall base

**Visuelle Wall Base**

Roppe Corporation, USA  
 1602 North Union Street  
 Fostoria, OH 44830  
 800-537-9527  
[www.roppe.com](http://www.roppe.com)



## 241b. Wall base

**Johnsonite “Millwork” Contours Wall Base – PV4065**

Roppe Corporation, USA  
 1602 North Union Street  
 Fostoria, OH 44830  
 800-537-9527  
[www.roppe.com](http://www.roppe.com)

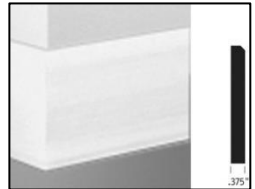

## 245a. Sheet vinyl flooring

**Homogeneous Vinyl Sheet Flooring**

Armstrong Flooring, Inc.  
 P.O. Box 3025  
 Lancaster, PA 17604  
 888-276-7876  
[www.armstrong.com](http://www.armstrong.com)

Product information included in this document is intended for illustration of one or more specific items that are deemed appropriate for use in this type of facility. Comparable products by other manufacturers that meet the same design criteria may be substituted after careful comparison.

## 245b. Sheet vinyl flooring

***noraplan sheet flooring***

nora® systems, Inc.  
 9 Northeastern Blvd.  
 Salem, NH 03079  
 800-332-NORA  
[www.nora.com/us](http://www.nora.com/us)

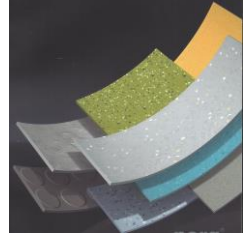

## 250a. Seamless floors and base

***Cheminert K flooring***

Dex-O-Tex  
 Division of Crossfield Products Corp.  
 140 Valley Road  
 Roselle Park, NJ 07204  
 908-245-2800  
[www.dexotex.com](http://www.dexotex.com)

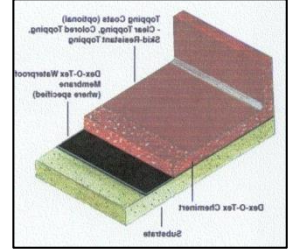

## 250b. Seamless floors and base

***Seamless flooring systems***

Dur-A-Flex, Inc.  
 95 Goodwin Street  
 East Hartford, CT 06108  
 877-2 51-5418  
[www.dur-a-flex.com](http://www.dur-a-flex.com)

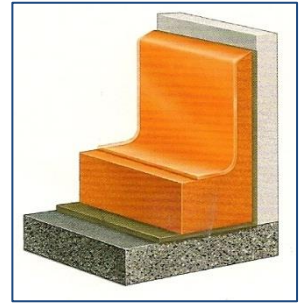

## 255. Carpet

***Mohawk Group GL 182 Exotic Fauna Sheet Carpet with Unibond Plus Bloc backing***

Mohawk Group  
 160 South Industrial Blvd.  
 Calhoun, GA 30701  
 800-554-6637  
[www.Mohawkgroup.com](http://www.Mohawkgroup.com)

Product information included in this document is intended for illustration of one or more specific items that are deemed appropriate for use in this type of facility. Comparable products by other manufacturers that meet the same design criteria may be substituted after careful comparison.



## 270a. Wall padding

**Gold Medal Safety Padding®**

Marathon Engineering Corporation  
5615 2nd Street West  
Lehigh Acres, FL 33913  
239-303-7378

<https://goldmedalsafetypadding.com>



## 270b. Wall padding

**Surface padding systems**

Padded Surfaces by B&E  
2339 Distributors Drive  
Indianapolis, IN 46241  
888-243-8788

<http://paddedsurfaces.com>

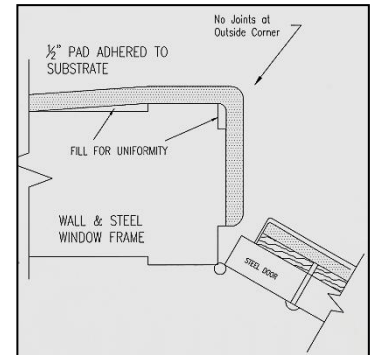

## 272. Seclusion room wall and floor material

**Lonfloor Plain – smooth**

Lonseal, Inc.  
928 East 238th Street  
Carson, CA 90745  
800-832-7111

[www.lonseal.com](http://www.lonseal.com)

## 280. Wall finish (do not use on floors)

**Sto; Decocoat®**

Sto Americas  
3800 Camp Creek Parkway SW  
Building 1400, Suite 120  
Atlanta, GA 30331  
800-221-2397

[www.stocorp.com](http://www.stocorp.com)

Product information included in this document is intended for illustration of one or more specific items that are deemed appropriate for use in this type of facility. Comparable products by other manufacturers that meet the same design criteria may be substituted after careful comparison.

290a. TV enclosure – suicide-resistant

**TE450 Ligature-Resistant Protective TV Enclosure**

Behavioral Safety Products

29A N. Main St., Suite 3

Watkinsville, GA 30677

706-705-1500

[www.besafepro.com](http://www.besafepro.com)

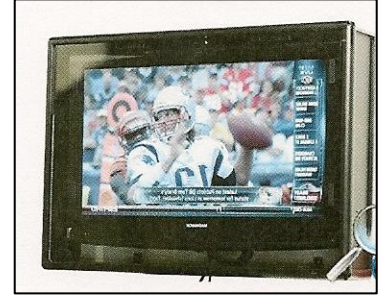

290b. TV Enclosure – suicide resistant

**Protective Enclosures, FPE55F(H)-S**

Peerless A-V

2300 White Oak Circle

Aurora, IL 60502

800-865-2112

[www.perlessmounts.com](http://www.perlessmounts.com)

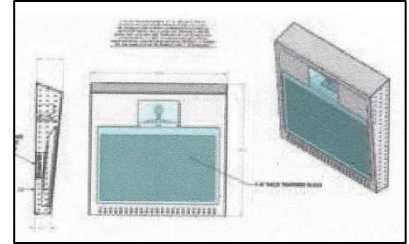

290c. TV enclosure – suicide-resistant

**Ligature-resistant TV enclosure**

ProEnc

101 Hudson Street

Jersey City, NJ 07302

862-234-5981

[www.lcdtvenclosure.com](http://www.lcdtvenclosure.com)

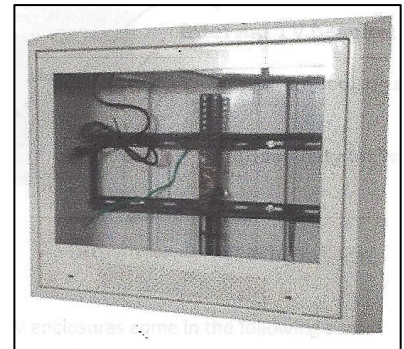

300a. Room signs

**Flxsigns**

2/90 Sign Systems

5350 Corporate Grove Blvd. SE

Grand Rapids, MI 49512

800-777-4310

[http://www.290signs.com/images/stories/pdf/Literature/FlxSignFlyer\\_7.14.pdf](http://www.290signs.com/images/stories/pdf/Literature/FlxSignFlyer_7.14.pdf)



Product information included in this document is intended for illustration of one or more specific items that are deemed appropriate for use in this type of facility. Comparable products by other manufacturers that meet the same design criteria may be substituted after careful comparison.

## 300b. Room signs

**Secure + spec**

Creative Signage Systems, Inc.  
 9101 51st Place  
 College Park, MD 20740  
 800-220-7446  
[www.creativesignage.com](http://www.creativesignage.com)



## 300c. Room signs

**KING KMS® Modular Sign System**

King Architectural Products  
 31 Simpson Road  
 Bolton, ON, Canada, L7E 2R6  
 877-857-2804  
[www.kingarchitecturalproducts.com](http://www.kingarchitecturalproducts.com)



## 301. Vinyl artwork

**Soft Suicide Prevention Artwork (SSPA)**

Kennon Products, Inc.  
 2071 N. Main Street  
 Sheridan, WY 82801  
 307-674-6498  
[www.suicideproofing.com](http://www.suicideproofing.com)



## 302a. Ligature-resistant frames

**Solid surface frames**

Custom Design Frameworks  
 3998 Fox Hunter Lane  
 Mechanicsville, VA 23111  
 804-476-4233  
[www.customdesignframeworks.com](http://www.customdesignframeworks.com)



Product information included in this document is intended for illustration of one or more specific items that are deemed appropriate for use in this type of facility. Comparable products by other manufacturers that meet the same design criteria may be substituted after careful comparison.

## 302b. Ligature-resistant frames

**AF550 Ligature-Resistant Art Frame**

Behavioral Safety Products

29A N. Main St., Suite 3

Watkinsville, GA 30677

706-705-1500

[www.besafepro.com](http://www.besafepro.com)

## 303. Display boards

**Tak-Les Bulletin Board with Guardian Frame**

RAO Contract Sales, Inc.

94 Fulton Street

Paterson, NJ 07501

800-445-7065

[www.rao.com](http://www.rao.com)

## 320a. Synthetic wall protection

**Avonite® Acrylic products - Wall Protection**

Avonite

1945 Highway 304

Belen, NM 87002

800-4-AVONITE

[www.avonitesurfaces.com](http://www.avonitesurfaces.com)

## 320b. Synthetic wall protection

**Acrovyn by Design® Wall Protection**

Construction Specialties

6696 State Road 405

Muncy, PA 17756

800-233-8493

[www.c-sgroup.com](http://www.c-sgroup.com)

Product information included in this document is intended for illustration of one or more specific items that are deemed appropriate for use in this type of facility. Comparable products by other manufacturers that meet the same design criteria may be substituted after careful comparison.

## 330a. Corridor handrail

**Acrovyn® ligature-resistant handrail with continuous aluminum mounting bracket**

Construction Specialties  
 6696 State Road 405  
 Muncy, PA 17756  
 800-233-8493  
[www.c-sgroup.com](http://www.c-sgroup.com)

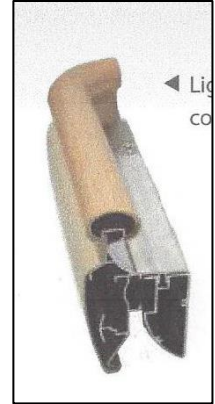

## 332a. Grab bar

**SAFEBAR® grab bar**

Cascade Specialty Hardware, Inc.  
 1413 Lincoln Avenue  
 Vancouver, WA 98660  
 360-823-3995  
[www.cascadesh.com](http://www.cascadesh.com)

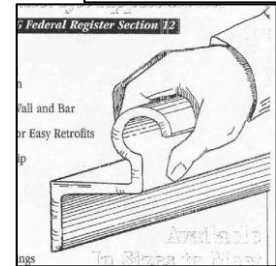

## 332b. Grab bar

**811-S01 SafeSupport® Safe-T Grab Bar**

Weizel Security  
 800-308-3627  
<http://www.securingshospitals.com/>

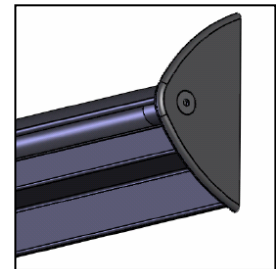

## 332c. Grab bar

**NW SecurityBar®**

Northwest Specialty Hardware, Inc.  
 15865 SE 114th Avenue, Suite C  
 Clackamas, OR 97015  
 503-557-1881  
<http://www.northwestsh.com/>

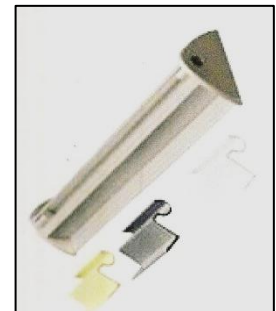

## 337. Grab bar – vertical

**SP-3V Vertical Grab Bar**

Odd Ball Industries  
 P.O. Box 376  
 Greenlawn, NY 11740  
 631-754-0400  
[www.oddballindustries.com](http://www.oddballindustries.com)



Cross-section with finished end

Product information included in this document is intended for illustration of one or more specific items that are deemed appropriate for use in this type of facility. Comparable products by other manufacturers that meet the same design criteria may be substituted after careful comparison.



## 340. Paper towel dispenser

**817-S45 SR™ Paper Towel Dispenser Cover**

Weizel Security

800-308-3627

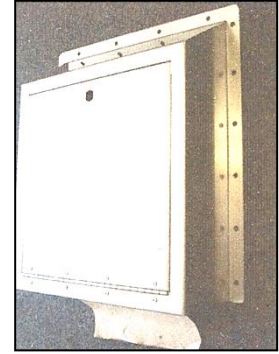
[www.securingshospitals.com](http://www.securingshospitals.com)

## 340b. Paper towel dispenser

**LG02 Paper Towel Dispenser**

Kingsway Group USA

2807 Samoset Road, Suite 200

Royal Oak, MI 48073

800-783-7980

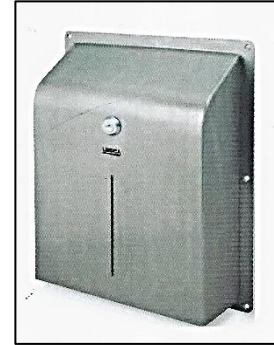
[www.kingswaygroupusa.com](http://www.kingswaygroupusa.com)

## 341. Roll Paper Towel Dispenser

**Whitehall MFG.; Model WH1848B Roll Paper Towel Dispenser**

Whitehall Manufacturing

P.O. Box 3257

City of Industry, CA 91744

1-800-782-7706

[www.whitehallmfg.com](http://www.whitehallmfg.com)

## 350e. Robe hook – breakaway

**LG180 Logica Coat Hook**

Kingsway Group USA

2807 Samoset Road, Suite 200

Royal Oak, MI 48073

800-783-7980

[www.kingswaygroupusa.com](http://www.kingswaygroupusa.com)

Product information included in this document is intended for illustration of one or more specific items that are deemed appropriate for use in this type of facility. Comparable products by other manufacturers that meet the same design criteria may be substituted after careful comparison.



## 360a. Security Mirrors

**ROVAL™ stainless steel mirror #20650-B**

American Specialties, Inc.  
 441 Saw Mill River Road  
 Yonkers, NY 10701  
 914-476-9000  
[www.americanspecialties.com](http://www.americanspecialties.com)



## 360b. Security Mirrors

**McGrory Glass Security mirror JOC-161**

McGrory Glass Inc.  
 1400 Grandview Avenue  
 Paulsboro, NJ 08066  
 856-579-3200  
[www.mcgrory-glass.com](http://www.mcgrory-glass.com)

## 360b. Security Mirrors

**McGrory Glass Security mirror JOC-161**

McGrory Glass Inc.  
 1400 Grandview Avenue  
 Paulsboro, NJ 08066  
 856-579-3200  
[www.mcgrory-glass.com](http://www.mcgrory-glass.com)

## 361a. Mirror guard

**SP-8 Mirror Guard**

Odd Ball Industries  
 P.O. Box 376  
 Greenlawn, NY 11740  
 631-754-0400  
[www.oddballindustries.com](http://www.oddballindustries.com)



## 370a. Recessed shelf

**SA47 Recessed Shelf – chase mounted**

Bradley Corporation  
 W142N9101 Fountain Boulevard  
 Menomonee Falls, WI 53051  
 800-272-3539  
[www.bradleycorp.com](http://www.bradleycorp.com)



Product information included in this document is intended for illustration of one or more specific items that are deemed appropriate for use in this type of facility. Comparable products by other manufacturers that meet the same design criteria may be substituted after careful comparison.

## 370c. Recessed shelf

**WH1820FA BestCare® Recessed Shelf – front mount**

Whitehall Manufacturing  
 P.O. Box 3527  
 City of Industry, CA 91744-0527  
 800-782-7706  
[www.whitehallmfg.com](http://www.whitehallmfg.com)



## 371c. Shelf – surface-mounted

**SA56 Bookshelf**

Bradley Corporation  
 W142N9101 Fountain Boulevard  
 Menomonee Falls, WI 53051  
 800-272-3539  
[www.bradleycorp.com](http://www.bradleycorp.com)

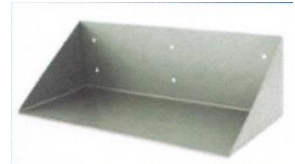

## 380a. Shower seat

**ADA Shower Seat**

Norix Group, Inc.  
 1800 W. Hawthorne Lane, Suite N  
 West Chicago, IL 60185  
 800-234-4900  
[www.norix.com](http://www.norix.com)



## 380b. Shower seat

**ADA Shower Seat**

Brey-Krause Manufacturing Co.  
 1209 W. Lehigh Street  
 Bethlehem, PA 18018  
 610-867-1401  
[www.breykrause.com](http://www.breykrause.com)

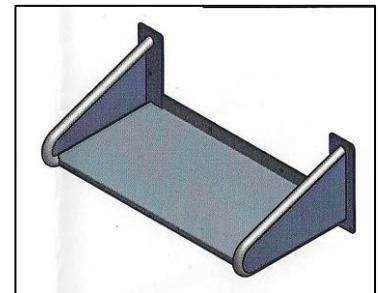

## 390a. Soap dish

**Recessed Soap Dish**

Norix Group, Inc.  
 1800 W. Hawthorne Lane, Suite N  
 West Chicago, IL 60185  
 800-234-4900  
[www.norix.com](http://www.norix.com)



Product information included in this document is intended for illustration of one or more specific items that are deemed appropriate for use in this type of facility. Comparable products by other manufacturers that meet the same design criteria may be substituted after careful comparison.

## 390b. Soap dish

**S-2632-SS Heavy-Duty Recessed Soap Dish without lip**

Brey-Krause Manufacturing Co.

1209 W. Lehigh Street

Bethlehem, PA 18018

610-867-1401

[www.breykrause.com](http://www.breykrause.com)

## 391a. Soap dispenser

**Suicide Prevention Soap Dispenser**

Norva Plastics, Inc.

3911 Killam Ave.

Norfolk, VA 23508

800-826-0758

[www.norvaplastics.com](http://www.norvaplastics.com)

## 391c. Soap dispenser

**OPS® 1-Touch™ Foaming Hand Soap Dispenser – ligature-resistant**

Archer Manufacturing

Danville, CA

800-796-5545

[www.vandalproof.org](http://www.vandalproof.org)

## 391e. Soap dispenser

**ADX-12™ Security Enclosure**

GOJO Industries, Inc.

One GOJO Plaza, Suite 500

Akron, OH 44309

800-321-9647

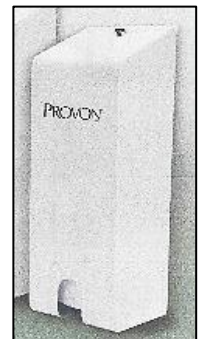
[www.gojo.com](http://www.gojo.com)

Product information included in this document is intended for illustration of one or more specific items that are deemed appropriate for use in this type of facility. Comparable products by other manufacturers that meet the same design criteria may be substituted after careful comparison.

## 400a. Toilet paper holder

**LG13 Toilet Roll Holder**

Kingsway Group USA  
2807 Samoset Road, Suite 200  
Royal Oak, MI 48073  
800-783-7980

[www.kingswaygroupusa.com](http://www.kingswaygroupusa.com)



## 400b. Toilet paper holder

**SP-5 Recessed Toilet Paper Holder**

Odd Ball Industries Mfg. Co., Inc.  
P.O. Box 376  
Greenlawn, NY 11740  
631-754-0400

[www.oddballindustries.com](http://www.oddballindustries.com)

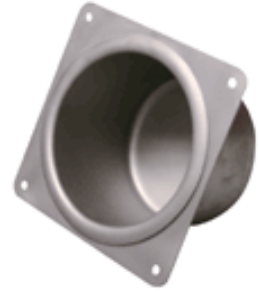

## 400c. Toilet paper holder

**S-4080-SS Recessed Toilet Paper Holder – exposed mount**

Brey-Krause Manufacturing Co.  
1209 W. Lehigh Street  
Bethlehem, PA 18018  
610-867-1401

[www.breykrause.com](http://www.breykrause.com)



## 400d. Toilet paper holder

**Toilet Paper Holder**

Norix Group, Inc.  
1800 W. Hawthorne Lane, Suite N  
West Chicago, IL 60185  
800-234-4900

[www.norix.com](http://www.norix.com)

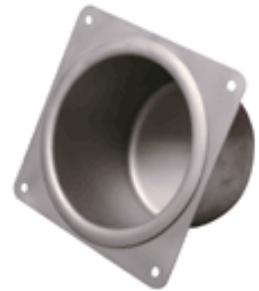

## 400e. Toilet paper holder

**C-400 Safety Toilet Paper Holder**

Cascade Specialty Hardware, Inc.  
1413 Lincoln Avenue  
Vancouver, WA 98660  
360-823-3995

[www.cascadesh.com](http://www.cascadesh.com)



Product information included in this document is intended for illustration of one or more specific items that are deemed appropriate for use in this type of facility. Comparable products by other manufacturers that meet the same design criteria may be substituted after careful comparison.

400f. Toilet paper holder

**WH1845A BestCare® Recessed Auto-Release Toilet Paper Holder – front mount**

Whitehall Manufacturing  
P.O. Box 3527  
City of Industry, CA 91744-0527  
800-782-7706  
[www.whitehallmfg.com](http://www.whitehallmfg.com)



400g. Toilet paper holder

**817-S59 SR™ Maryland Toilet Paper Dispenser**

Weizel Security  
800-308-3627  
[www.securingshospitals.com](http://www.securingshospitals.com)



400h. Toilet paper holder

**Suicide-Resistant Toilet Paper Dispenser**

Norva Plastics, Inc.  
3911 Killam Ave.  
Norfolk, VA 23508  
800-826-0758  
[www.norvaplastics.com](http://www.norvaplastics.com)



410a. Undersink protection

**Truebro® Lav Shield®**

IPS® Corporation  
455 W. Victoria Street  
Compton, CA 90220  
310-898-3300  
[www.truebro.com](http://www.truebro.com)

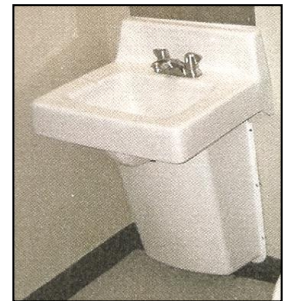

Product information included in this document is intended for illustration of one or more specific items that are deemed appropriate for use in this type of facility. Comparable products by other manufacturers that meet the same design criteria may be substituted after careful comparison.

## 410b. Undersink protection

**831-S27 SR™ Undersink Enclosure**

Weizel Security

800-308-3627

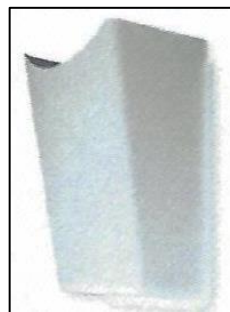
[www.securingshospitals.com](http://www.securingshospitals.com)

## 420a. Convex mirrors

**DuraVision Quarter Dome Mirror**

Norix Group, Inc.

1800 W. Hawthorne Lane, Suite N

West Chicago, IL 60185

800-234-4900

[www.norix.com](http://www.norix.com)

## 420c. Convex mirrors

**815-S51 SR™ Steel Dome Mirror**

Weizel Security

800-308-3627

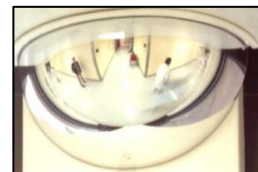
[www.securingshospitals.com](http://www.securingshospitals.com)

## 440a. Roller blinds

**Webb Lok cordless roller shades**

WebbShade

522 Front Street

El Cajon, CA 92020

800-262-9322

[www.webbshade.com](http://www.webbshade.com)

## 440b. Roller blinds

**FlexShades for Healthcare Facilities**

Draper, Inc.

411 South Pearl Street

Spiceland, IN 47385

800-238-7999

[www.draperinc.com](http://www.draperinc.com)

Product information included in this document is intended for illustration of one or more specific items that are deemed appropriate for use in this type of facility. Comparable products by other manufacturers that meet the same design criteria may be substituted after careful comparison.



## 460a. Cabinet pulls

**DP74C Cabinet Pull**

Doug Mockett & Company, Inc.  
 1915 Abalone Ave.  
 Torrance, CA 90501  
 800-523-1269  
[www.mockett.com](http://www.mockett.com)

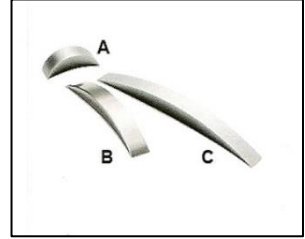

## 460b. Cabinet pulls

**UT-105/S Pressure Fit Recess Pull**

Sugatsune America, Inc.  
 18101 Savarona Way  
 Carson, CA 90746  
 800-562-5267  
[www.sugatsune.com](http://www.sugatsune.com)



## 460c. Cabinet pulls

**Top Knobs – Mayfair Cup Pull attached with tamper-resistant fasteners**

My Knobs.com  
 485 S. Broadway  
 Hicksville, NY 11801  
 866-695-6627  
[www.myknobs.com](http://www.myknobs.com)



## 460d. Cabinet pulls

**104.66.200 Zinc Handle – polished chrome finish**

Hafele America Co.  
 3901 Cheyenne Drive  
 Archdale, NC 27263  
 800-423-3531  
[www.hafele.com/us/en](http://www.hafele.com/us/en)



Product information included in this document is intended for illustration of one or more specific items that are deemed appropriate for use in this type of facility. Comparable products by other manufacturers that meet the same design criteria may be substituted after careful comparison.

465a. Cabinet locks – keyless

**300 Series eLock®: Cabinet version**

CompX Security Products  
715 Center Street  
Grayslake, IL 60030  
847-752-2500

[www.compxelock.com](http://www.compxelock.com)



465b. Cabinet locks – keyless

**diallock**

Hafele America Co.  
3901 Cheyenne Drive  
Archdale, NC 27263  
800-423-3531

[www.hafele.com/us/en](http://www.hafele.com/us/en)

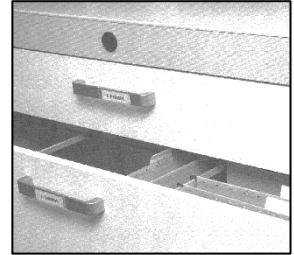

465c. Cabinet locks – keyless

**100 Series eLock: Cabinet Version**

CompX Security Products  
P. O. Box 200  
Mauldin, SC 29662  
864-297-6655

[www.compxelock.com](http://www.compxelock.com)



470a. Tamper-resistant screws

**Tamperproof screws**

Tamperproof Screw Company, Inc.  
30 Laurel Street  
Hicksville, NY 11801  
516-931-1616

[www.tamperproof.com](http://www.tamperproof.com)



470b. Tamper-resistant screws

**Security Pin Torx Screws and Bits**

Northwest Specialty Hardware, Inc.  
15865 SE 114th Avenue, Suite C  
Clackamas, OR 97015  
503-557-1881

[www.northwestsh.com](http://www.northwestsh.com)



Product information included in this document is intended for illustration of one or more specific items that are deemed appropriate for use in this type of facility. Comparable products by other manufacturers that meet the same design criteria may be substituted after careful comparison.

## 473a. Shower doors

**Sentinel Event Reduction Shower Door**

Norva Plastics, Inc.  
 3911 Killam Ave.  
 Norfolk, VA 23508  
 800-826-0758  
[www.norvaplastics.com](http://www.norvaplastics.com)

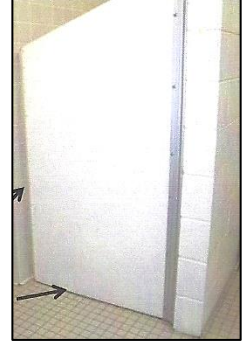

## 479a. Stools

**OFS Brands; Boost Ottoman**

OFS Brands  
 1204 East Sixth Street  
 Huntingburg, IN 47542  
 800-521-5381  
[www.info@ofsbrands.com](mailto:www.info@ofsbrands.com)



## 479a. Stools

**Norix: Slammer Stool Series**

Norix Group, Inc.  
 1800 W. Hawthorne Lane, Suite N  
 West Chicago, IL 60185  
 800-234-4900  
[www.norix.com](http://www.norix.com)

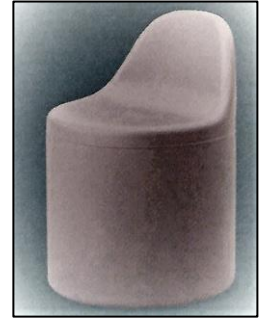

## 480. Sand-ballasted seating

**Ultra-Max Series**

Norix Group, Inc.  
 1800 W. Hawthorne Lane, Suite N  
 West Chicago, IL 60185  
 800-234-4900  
[www.norix.com](http://www.norix.com)



Product information included in this document is intended for illustration of one or more specific items that are deemed appropriate for use in this type of facility. Comparable products by other manufacturers that meet the same design criteria may be substituted after careful comparison.

## 481a. Lightweight seating

**Integra Series chairs**

Norix Group, Inc.  
 1800 W. Hawthorne Lane, Suite N  
 West Chicago, IL 60185  
 800-234-4900  
[www.norix.com](http://www.norix.com)



## 481b. Lightweight seating

**RazorBack Chair**

Cortech® USA  
 7530 Plaza Court  
 Willowbrook, IL 60527  
 800-571-0770  
[www.cortechusa.com](http://www.cortechusa.com)



## 481c. Lightweight seating

**5000-20 Modumaxx stackable chair**

Moduform  
 172 Industrial Road  
 Fitchburg, MA 01420  
 800-221-6638  
[www.moduform.com](http://www.moduform.com)



## 482a. Upholstered seating

**Sierra Series chairs with solid end arms**

Norix Group, Inc.  
 1800 W. Hawthorne Lane, Suite N  
 West Chicago, IL 60185  
 800-234-4900  
[www.norix.com](http://www.norix.com)



## 482b. Upholstered seating

**ML30/27BH Meridian Behavioral Health Seating – chair**

Nemschoff  
 909 North 8th Street  
 Sheboygan, WI 53081  
 800-203-8916  
[www.nemschoff.com](http://www.nemschoff.com)



Product information included in this document is intended for illustration of one or more specific items that are deemed appropriate for use in this type of facility. Comparable products by other manufacturers that meet the same design criteria may be substituted after careful comparison.

## 482c. Upholstered seating

**Endurance Series**

Blockhouse Company, Inc.  
3285 Farmtrail Road  
York, PA 17406  
800-346-1126  
[www.blockhouse.com](http://www.blockhouse.com)

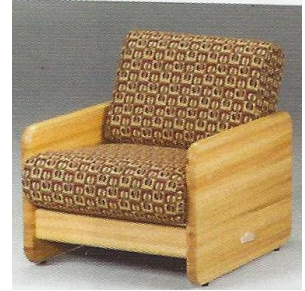

## 482d. Upholstered seating

**Dignity Series**

Spec Furniture Inc.  
65 City View Drive  
Toronto, Ontario M9W 5B1  
Canada  
888-761-7732  
[www.specfurniture.com](http://www.specfurniture.com)



## 482e. Upholstered seating

**Carrara**

Kwalu  
6160 Peachtree Dunwoody Rd., Building C  
Atlanta, GA 30328  
877-695-9258  
[www.kwalu.com](http://www.kwalu.com)



## 482f. Upholstered seating

**Arcadia Series**

Blockhouse Company, Inc.  
3285 Farmtrail Road  
York, PA 17406  
800-346-1126  
[www.blockhouse.com](http://www.blockhouse.com)



## 484c. PVC molded seating

**Forté™ Lounge**

Norix Group, Inc.  
1800 W. Hawthorne Lane, Suite N  
West Chicago, IL 60185  
800-234-4900  
[www.norix.com](http://www.norix.com)

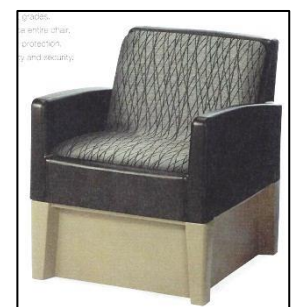
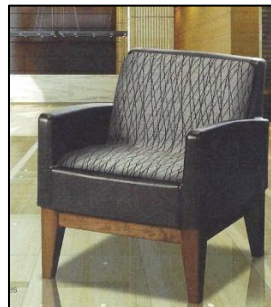

Product information included in this document is intended for illustration of one or more specific items that are deemed appropriate for use in this type of facility. Comparable products by other manufacturers that meet the same design criteria may be substituted after careful comparison.



484d. PVC molded seating

**Hondo® Nuevo**

Norix Group, Inc.  
1800 W. Hawthorne Lane, Suite N  
West Chicago, IL 60185  
800-234-4900  
[www.norix.com](http://www.norix.com)



484e. PVC molded seating

**RockSmart**

Norix Group, Inc.  
1800 W. Hawthorne Lane, Suite N  
West Chicago, IL 60185  
800-234-4900  
[www.norix.com](http://www.norix.com)



485a. Tables

**Jupiter Series Tables**

Norix Group, Inc.  
1800 W. Hawthorne Lane, Suite N  
West Chicago, IL 60185  
800-234-4900  
[www.norix.com](http://www.norix.com)



485b. Tables

**Madera Series Tables**

Norix Group, Inc.  
1800 W. Hawthorne Lane, Suite N  
West Chicago, IL 60185  
800-234-4900  
[www.norix.com](http://www.norix.com)



Product information included in this document is intended for illustration of one or more specific items that are deemed appropriate for use in this type of facility. Comparable products by other manufacturers that meet the same design criteria may be substituted after careful comparison.



## 490a. Electrically adjustable hospital bed

**Behavioral Health Bed™**

Sizewise

8601 Monrovia Street

Lenexa, KS 66215

800-814-9389

[www.sizewise.com](http://www.sizewise.com)

## 490b. Electrically adjustable hospital bed

**Spirit Bed with Mental Health Package**

CHG Hospital Beds

1020 Adelaide Street S.

London, ON N6E 1R6

Canada

866-516-5446

[www.chgbeds.com](http://www.chgbeds.com)

## 490c. Electrically adjustable hospital bed

**S3 MedSurg Bed**

Stryker

2825 Airview Avenue

Kalamazoo, MI 49002

269-385-2600

[www.stryker.com](http://www.stryker.com)

## 491. Manually adjustable hospital bed

**Psych Bed**

Stryker

3800 East Centre Avenue

Portage, MI 49002

269-385-2600

[www.stryker.com](http://www.stryker.com)

## 492b. Behavioral health mattresses

**Comfort Shield® Remedy Sealed Seam Mattress**

Norix Group, Inc.

1800 W. Hawthorne Lane, Suite N

West Chicago, IL 60185

800-234-4900

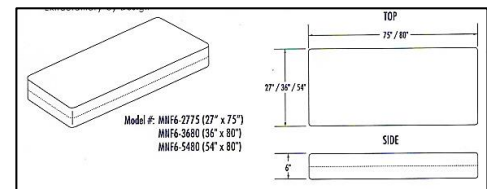
[www.norix.com](http://www.norix.com)

Product information included in this document is intended for illustration of one or more specific items that are deemed appropriate for use in this type of facility. Comparable products by other manufacturers that meet the same design criteria may be substituted after careful comparison.

## 492c. Behavioral Health Mattresses

***Sizewise Victory Series Mattresses***

Sizewise

1600 Genessee, Suite 950

Kansas City, MO 64102

800-814-9389

[www.sizewise.net](http://www.sizewise.net)

## 492d. Behavioral health mattresses

***Behavioral Health Mattress with Bed Bug Protection & BioArmour™ Infection Control Composite Lamination Surface***

American Innovation Products

12004 Trinity Road

Trinity, NC 27370

814-490-0660

[www.americaninnovationproducts.com](http://www.americaninnovationproducts.com)

## 492e. Behavioral health mattresses

***Closed System™ Behavioral Health Mattress***

Comfortex®

1680 Wilkie Drive

Winona, MN 55987

800-445-4007

[www.comfortexinc.com](http://www.comfortexinc.com)

## 493a. Platform bed

***Roto Cast Series***

Norix Group, Inc.

1800 W. Hawthorne Lane, Suite N

West Chicago, IL 60185

800-234-4900

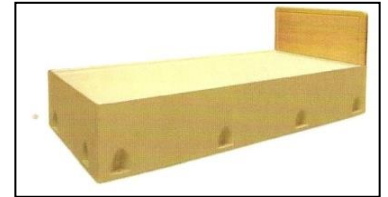
[www.norix.com](http://www.norix.com)

## 493d. Platform bed

***BHBP/68 and BHHD/68 Behavioral Health Beds***

Nemschoff

909 North 8th Street

Sheboygan, WI 53081

800-203-8916

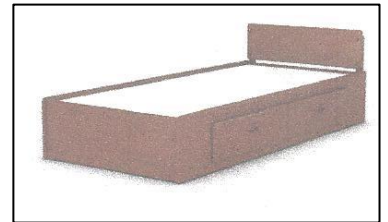
[www.nemschoff.com/](http://www.nemschoff.com/)

Product information included in this document is intended for illustration of one or more specific items that are deemed appropriate for use in this type of facility. Comparable products by other manufacturers that meet the same design criteria may be substituted after careful comparison.

## 493e. Platform bed

**Endurance Bed**

Cortech® USA  
 7530 Plaza Court  
 Willowbrook, IL 60527  
 800-571-0770  
[www.cortechusa.com](http://www.cortechusa.com)



## 494a. Platform bed – lift-accessible

**Sleigh Bed**

Norix Group, Inc.  
 1800 W. Hawthorne Lane, Suite N  
 West Chicago, IL 60185  
 800-234-4900  
[www.norix.com](http://www.norix.com)



## 494b. Platform bed riser – lift-accessible

**Platform Bed Riser**

Norix Group, Inc.  
 1800 W. Hawthorne Lane, Suite N  
 West Chicago, IL 60185  
 800-234-4900  
[www.norix.com](http://www.norix.com)



## 495a. Patient room furniture

**VISTA Series**

Blockhouse Company, Inc.  
 3285 Farmtrail Road  
 York, PA 17406  
 800-346-1126  
[www.blockhouse.com](http://www.blockhouse.com)

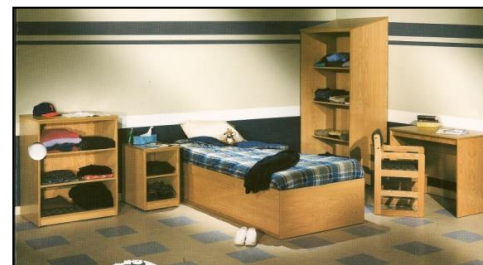

## 495b. Patient room furniture

**Safehouse Series**

Norix Group, Inc.  
 1800 W. Hawthorne Lane, Suite N  
 West Chicago, IL 60185  
 800-234-4900  
[www.norix.com](http://www.norix.com)

Product information included in this document is intended for illustration of one or more specific items that are deemed appropriate for use in this type of facility. Comparable products by other manufacturers that meet the same design criteria may be substituted after careful comparison.

## 495c. Patient room furniture

**Safe & Tough series**

This End Up® Furniture Company, Inc.  
 500 N. 7th Street  
 Sanford, NC 27331  
 800-605-2130  
[www.thisendup.com/groupliving.com](http://www.thisendup.com/groupliving.com)

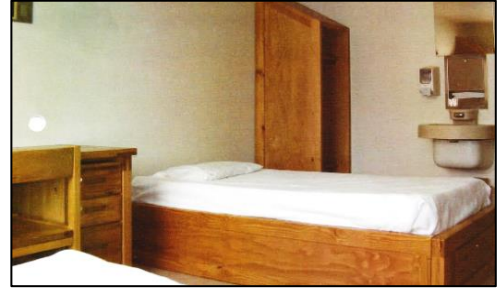

## 495d. Patient room furniture

**Endurance Series**

Cortech® USA  
 7530 Plaza Court  
 Willowbrook, IL 60527  
 800-571-0770  
[www.cortechusa.com](http://www.cortechusa.com)



## 495e. Patient room furniture

**Attenda Series**

Norix Group, Inc.  
 1800 W. Hawthorne Lane, Suite N  
 West Chicago, IL 60185  
 800-234-4900  
[www.norix.com](http://www.norix.com)



## 496a. Patient room furniture

**Attenda Series**

Norix Group, Inc.  
 1800 W. Hawthorne Lane, Suite N  
 West Chicago, IL 60185  
 800-234-4900  
[www.norix.com](http://www.norix.com)



Product information included in this document is intended for illustration of one or more specific items that are deemed appropriate for use in this type of facility. Comparable products by other manufacturers that meet the same design criteria may be substituted after careful comparison.

## 496b. Patient room furniture

**Fortress Wardrobes**

Moduform  
 172 Industrial Road  
 Fitchburg, MA 01420  
 800-221-6638  
[www.moduform.com](http://www.moduform.com)

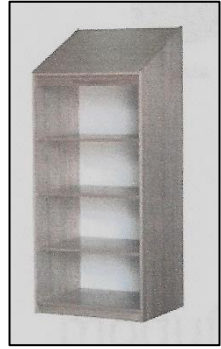

## 498. Seclusion room bed

**450 Series Seclusion Beds (restraint loops optional)**

Moduform  
 172 Industrial Road  
 Fitchburg, MA 01420  
 800-221-6638  
[www.moduform.com](http://www.moduform.com)



## 499a. Nurse servers

**WALLAroo®**

Carstens®, Inc.  
 7310 West Wilson Avenue  
 Chicago, IL 60706  
 800-782-1524  
[www.carstens.com](http://www.carstens.com)



## 499b. Nurse servers

**Proximity EXT-28**

Proximity Systems  
 800-437-8111  
[www.proximiiitysystems.com](http://www.proximiiitysystems.com)



Product information included in this document is intended for illustration of one or more specific items that are deemed appropriate for use in this type of facility. Comparable products by other manufacturers that meet the same design criteria may be substituted after careful comparison.



## 520a. Fire sprinklers

**Raven 5.6K Institutional Sprinklers**

TYCO Fire Protection Products  
 1400 Pennbrook Parkway  
 Lansdale, PA 19446  
 800-523-6512  
[www.tyco-fire.com](http://www.tyco-fire.com)



## 520b. Fire sprinklers

**819-S17 SR Sprinkler**

Weizel Security  
 800-308-3627  
[www.securingshospitals.com](http://www.securingshospitals.com)

## 521a. Fire extinguisher cabinet

**BestCare® Ligature-Resistant Recessed Fire Extinguisher Cabinet WH1704**

Whitehall Manufacturing  
 P.O. Box 3527  
 City of Industry, CA 91744-0527  
 800-782-7706  
[www.whitehallmfg.com](http://www.whitehallmfg.com)



## 531. Toilet fixture, ADA– floor-mounted, back outlet

**Huron EverClean Flushometer Toilet with integral seat**

American Standard  
 1 Centennial Avenue  
 Piscataway, NJ 08855  
 800-488-8049  
[www.americanstandard-us.com](http://www.americanstandard-us.com)



## 533. Solid-surface toilet fixture

**CWC-150 Behavioral HealthCare Toilet**

Intersan Manufacturing Company  
 1748 West Fillmore Street  
 Phoenix, AZ 85007  
 602-254-3101  
[www.intersan.us](http://www.intersan.us)



Product information included in this document is intended for illustration of one or more specific items that are deemed appropriate for use in this type of facility. Comparable products by other manufacturers that meet the same design criteria may be substituted after careful comparison.



## 534a. Stainless steel toilet

**ETW-1490 Series**

Willoughby Industries  
5105 West 78th Street  
Indianapolis, IN 46268  
800-428-4065

[www.willoughby-ind.com](http://www.willoughby-ind.com)



## 534b. Toilet fixture – stainless steel

**BestCare® Ligature-Resistant Toilet, Top Supply, WH2142**

Whitehall Manufacturing  
P.O. Box 3257  
City of Industry, CA 91744  
800-782-7706

[www.whitehallmfg.com](http://www.whitehallmfg.com)



## 536. Bariatric toilet fixtures

**BET-1490 Series – Bariatric toilets**

Willoughby Industries  
5105 West 78th Street  
Indianapolis, IN 46268  
800-428-4065

[www.willoughby-ind.com](http://www.willoughby-ind.com)



## 537. Toilet waste line clog removal assistant

**Nallyator**

Willoughby Industries  
5105 West 78th Street  
Indianapolis, IN 46268  
800-428-4065

[www.willoughby-ind.com](http://www.willoughby-ind.com)



## 538. Wall-hung toilet support

**Big John Toilet Support**

Big John Products, Inc.  
8533 Canoga Avenue, Suite D  
Canoga Park, CA 91304  
866-366-0669

[www.bigjohnproducts.com](http://www.bigjohnproducts.com)



Product information included in this document is intended for illustration of one or more specific items that are deemed appropriate for use in this type of facility. Comparable products by other manufacturers that meet the same design criteria may be substituted after careful comparison.

## 540a. Lavatories

**HSL1 SafeCare Ligature-Resistant Lavatory – stainless steel or high- impact polymer trap cover**

Bradley Corporation  
 W142N9101 Fountain Boulevard  
 Menomonee Falls, WI 53051  
 800-272-3539  
[www.bradleycorp.com](http://www.bradleycorp.com)



## 540c. Lavatories

**Intersan - Saniwave lavatory with extensions**

Intersan Manufacturing Company  
 1748 West Fillmore Street  
 Phoenix, AZ 85007  
 602-254-3101  
[www.intersan.us](http://www.intersan.us)



## 541a. Vanity top lavatory

**Suicide Prevention Patient Sink Faucet**

Norva Plastics, Inc  
 3911 Killam Ave.  
 Norfolk, VA 23508  
 800-826-0758  
[www.norvaplastics.com](http://www.norvaplastics.com)



## 541b. Vanity top lavatory

**Avonite® Acrylic Solid Surfaces**

Avonite Surfaces  
 7350 Empire Drive  
 Florence, KY 41042  
 800-354-9858  
[www.avonite.com](http://www.avonite.com)

## 550a. Shower head – institutional

**SP-7 Shower Head**

Odd Ball Industries Mfg. Co., Inc.  
 P.O. Box 376  
 Greenlawn, NY 11740  
 631-754-0400  
[www.oddballindustries.com](http://www.oddballindustries.com)

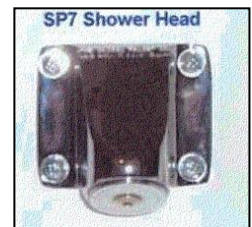

Product information included in this document is intended for illustration of one or more specific items that are deemed appropriate for use in this type of facility. Comparable products by other manufacturers that meet the same design criteria may be substituted after careful comparison.

550c. Shower head – institutional

**Ligature-Resistant Shower Head – SH330**

Behavioral Safety Products  
29A N. Main St., Suite 3  
Watkinsville, GA 30677  
706-705-1500  
[www.besafepro.com](http://www.besafepro.com)



552a. Shower Control Valve

**WH538-CSH Ligature-Resistant Shower Head and Valve**

Whitehall Manufacturing  
P.O. Box 3527  
City of Industry, CA 91744-0527  
800-782-7706  
[www.whitehallmfg.com](http://www.whitehallmfg.com)



552b. Shower valve

**Ligature-Resistant Shower Valve – SV230**

Behavioral Safety Products  
29A N. Main St., Suite 3  
Watkinsville, GA 30677  
706-705-1500  
[www.besafepro.com](http://www.besafepro.com)



552c. Shower valve

**834-S40 SR™ Retrofit Shower Knob**

Weizel Security  
800-308-3627  
[www.securingshospitals.com](http://www.securingshospitals.com)



552d. Shower valve

**SP-10 Shower Mixing Valve**

Odd Ball Industries  
P.O. Box 376  
Greenlawn, NY 11740  
1-631-754-0400  
[www.oddballindustries.com](http://www.oddballindustries.com)



Product information included in this document is intended for illustration of one or more specific items that are deemed appropriate for use in this type of facility. Comparable products by other manufacturers that meet the same design criteria may be substituted after careful comparison.

## 552e. Shower valve

***Sense™ DMV2 – Individual Shower concealed electronic mixing valve with optional stainless steel cover***

Armstrong International  
816 Maple Street  
Three Rivers, MI 49093  
269-273-1415

[www.armstronginternational.com](http://www.armstronginternational.com)

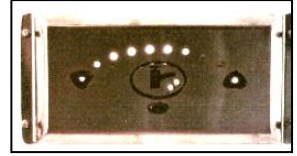

## 555a. Shower diverter valve

***834-SN2 SR™ Diverter Valve Assembly***

Weizel Security  
800-308-3627

[www.securingshospitals.com](http://www.securingshospitals.com)



## 555b. Shower diverter valve

***SP-12 Diverter Valve for shower***

Odd Ball Industries  
P.O. Box 376  
Greenlawn, NY 11740  
631-754-0400

[www.oddballindustries.com](http://www.oddballindustries.com)



## 560a. Shower assembly

***BestCare® Flush-Mount Ligature-Resistant Security Shower WH1741-CSH***

Whitehall Manufacturing  
P.O. Box 3527  
City of Industry, CA 91744-0527  
800-782-7706

[www.whitehallmfg.com](http://www.whitehallmfg.com)

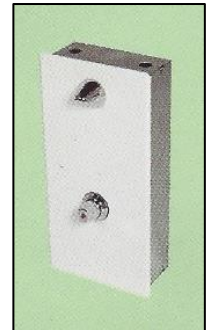

Product information included in this document is intended for illustration of one or more specific items that are deemed appropriate for use in this type of facility. Comparable products by other manufacturers that meet the same design criteria may be substituted after careful comparison.

## 560b. Shower assembly

**SR834-S35 SR™ Shower Panel**

Weizel Security

800-308-3627

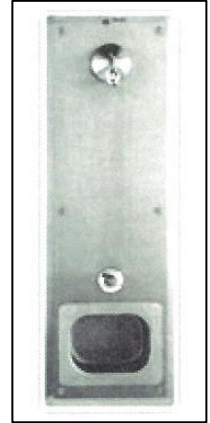
[www.securingshospitals.com](http://www.securingshospitals.com)

## 563a. Shower assembly – recessed hand-held

**M0418-E508 in locking box**

Acorn Engineering

15125 Proctor Avenue

City of Industry, CA 91746

800-488-8999

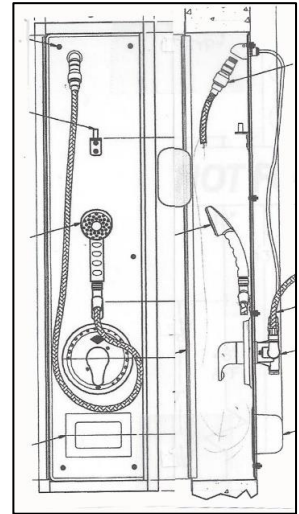
[www.acorneng.com](http://www.acorneng.com)

## 563b. Shower assembly – handicapped accessible

**Quick release hand held shower head; Model 40707**

Intersan Manufacturing Company

1748 West Fillmore Street

Phoenix, AZ 85007

800-999-3101

[www.intersanus.com](http://www.intersanus.com)

Product information included in this document is intended for illustration of one or more specific items that are deemed appropriate for use in this type of facility. Comparable products by other manufacturers that meet the same design criteria may be substituted after careful comparison.

563c. Shower assembly – handicapped accessible

**SP-7WC Shower Head with Quick Connect Hand Shower**

Odd Ball Industries

P.O. Box 376

Greenlawn, NY 11740

1-631-754-0400

[www.oddballindustries.com](http://www.oddballindustries.com)



563c. Shower assembly – handicapped accessible

**BestCare® Flush-Mount Ligature-Resistant Security Shower with Dual Heads WH1741-FH-CSH**

Whitehall Manufacturing

P.O. Box 3527

City of Industry, CA 91744-0527

800-782-7706

[www.whitehallmfg.com](http://www.whitehallmfg.com)

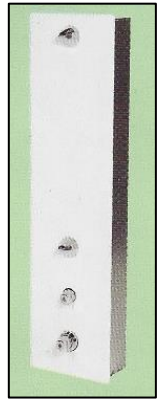

564a. Shower linear drain

**ProLine drain with “dots” cover**

QuickDrain USA

101 W. Main Street #206

Frisco, CO 80443

866-998-6685

[www.quickdrainusa.com](http://www.quickdrainusa.com)

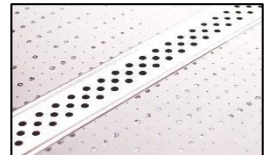

565a. Shower floor basin

**Roll-in shower with front trench**

Watermark

2969 armory Drive, Suite 400

Nashville, TN 37204

615-291-6111

[www.watermarksolidsurface.com/product-category/all-shower-systems/5](http://www.watermarksolidsurface.com/product-category/all-shower-systems/5)

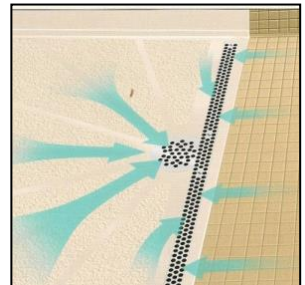

Product information included in this document is intended for illustration of one or more specific items that are deemed appropriate for use in this type of facility. Comparable products by other manufacturers that meet the same design criteria may be substituted after careful comparison.



## 565b. Shower floor basin

**AquaSurf solid surface shower bases**

Willoughby Industries  
5105 West 78th Street  
Indianapolis, IN 46268  
800-428-4065

[www.willoughby-ind.com](http://www.willoughby-ind.com)



## 566. One-piece patient toilet room floor

**UniFloor**

Bestbath®  
723 Garber Street  
Caldwell, ID 83605  
800-727-9907

[www.bestbath.com](http://www.bestbath.com)



## 568a. Pre-built bathrooms

**Pre-Built Bathrooms**

Eggrock, LLC  
265 Foster Street  
Littleton, MA 01460  
978-952-8800

[www.eggrock.com](http://www.eggrock.com)



## 568b. Pre-built bathrooms

**SurePods™**

Oldcastle®  
2300 Principal Row  
Orlando, FL 32837  
407-859-7034

<https://oldcastlesurepods.com>

## 570a. Lavatory faucet

**Ligature-Resistant Metering Faucet – SF380**

Behavioral Safety Products  
29A N. Main St., Suite 3  
Watkinsville, GA 30677  
706-705-1500

[www.besafepro.com](http://www.besafepro.com)

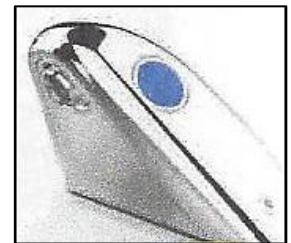

Product information included in this document is intended for illustration of one or more specific items that are deemed appropriate for use in this type of facility. Comparable products by other manufacturers that meet the same design criteria may be substituted after careful comparison.

570b. Lavatory faucet

***Suicide Prevention Patient Sink Faucet***

Norva Plastics, Inc  
3911 Killam Ave.  
Norfolk, VA 23508  
800-826-0758

[www.norvaplastics.com](http://www.norvaplastics.com)



570c. Lavatory faucet

***BestCare® Ligature-resistant, ADA-compliant faucet  
3374-PPZ***

Whitehall Manufacturing  
P.O. Box 3527  
City of Industry, CA 91744-0527  
800-782-7706

[www.whitehallmfg.com](http://www.whitehallmfg.com)

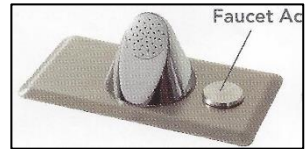

570d. Lavatory Faucet

***Two-button bubbler – R04 with hemispherical  
pushbuttons (PBH)***

Acorn Engineering Company  
P.O. Box 3527  
City of Industry, CA 91744  
800-488-8999

[www.acorneng.com](http://www.acorneng.com)

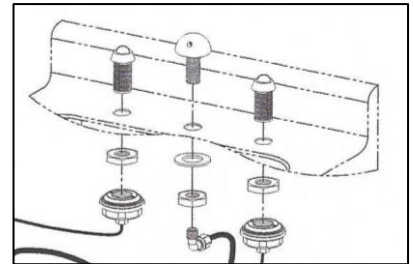

574. Lavatory with countertop valve

***Lavatory Valve***

Odd Ball Industries  
P.O. Box 376  
Greenlawn, NY 11740  
631-754-0400

[www.oddballindustries.com](http://www.oddballindustries.com)



Product information included in this document is intended for illustration of one or more specific items that are deemed appropriate for use in this type of facility. Comparable products by other manufacturers that meet the same design criteria may be substituted after careful comparison.

## 580. Recessed flush valve

**Royal 611 & WB-1-A Easy Access Wall Box**

Sloan®  
 10500 Seymour Avenue  
 Franklin Park, IL 60131  
 800-982-5839  
[www.sloan.com](http://www.sloan.com)



## 581a. Recessed flush valve

**Regal 955 Hydraulic Concealed Flushometer & WB-1-A Easy Access Wall Box**

Sloan®  
 10500 Seymour Avenue  
 Franklin Park, IL 60131  
 800-982-5839  
[www.sloan.com](http://www.sloan.com)

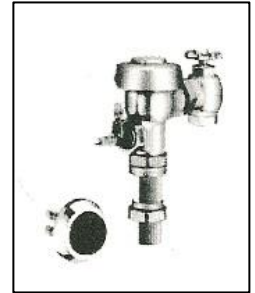

## 581b. Recessed flush valve

**3-inch Push Button Assembly for Concealed Flush Valves – P6000-NL3**

Zurn Industries  
 511 W. Freshwater Way  
 Milwaukee, WI 53204  
 855-663-9876  
[www.zurn.com](http://www.zurn.com)

## 585a. Flush valve cover

**HSC79 SafeCare Ligature-Resistant Flush Valve Cover**

Bradley Corporation  
 W142N9101 Fountain Boulevard Menomonee Falls, WI  
 53051  
 800-272-3539  
[www.bradleycorp.com](http://www.bradleycorp.com)



Product information included in this document is intended for illustration of one or more specific items that are deemed appropriate for use in this type of facility. Comparable products by other manufacturers that meet the same design criteria may be substituted after careful comparison.

585b. Flush valve cover

***FV500 (2 piece) & FV600 (1 piece) Ligature Resistant Flush Valve Cover***

Behavioral Safety Products  
29A N. Main St., Suite 3  
Watkinsville, GA 30677  
706-705-1500  
[www.besafepro.com](http://www.besafepro.com)

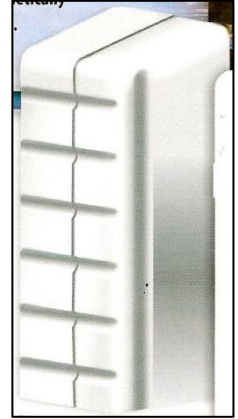

585c. Flush valve cover

***831-S39 SR™ Flush Valve Cover***

Weizel Security  
Unit 9 – 62 Fawcett Road  
Coquitlam, BC, Canada V3K 6V5  
800-308-3627  
[www.securingshospitals.com](http://www.securingshospitals.com)



585d. Flush valve cover

***Ligature-Resistant Box with Flush Valve WH2802 – for various toilet or urinal***

Whitehall Manufacturing  
P.O. Box 3527  
City of Industry, CA 91744-0527  
800-782-7706  
[www.whitehallmfg.com](http://www.whitehallmfg.com)

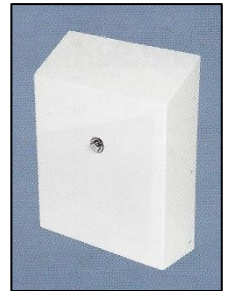

588. Recessed bedpan washer

***Recessed Bedpan Washer***

Willoughby Industries  
5105 West 78th Street  
Indianapolis, IN 46268  
800-428-4065  
[www.willoughby-ind.com](http://www.willoughby-ind.com)

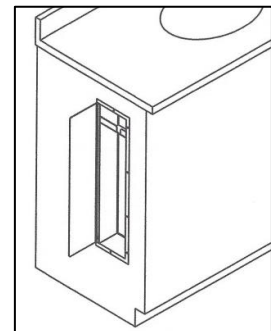
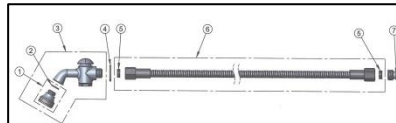

Product information included in this document is intended for illustration of one or more specific items that are deemed appropriate for use in this type of facility. Comparable products by other manufacturers that meet the same design criteria may be substituted after careful comparison.

## 590a. Medical gas covers

**Security Patient Console**

Hospital Systems, Inc.

750 Garcia Avenue

Pittsburg, CA 94565

925-427-7800

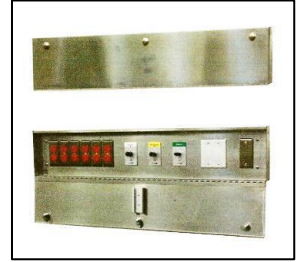
[www.hsiheadwalls.com](http://www.hsiheadwalls.com)

## 590b. Medical gas covers

**Recessed Security Console**

Modular Services Company

500 East Britton Road

Oklahoma City, OK 73114

800-687-0938

[www.modularservices.com/products-services/products-type/secure](http://www.modularservices.com/products-services/products-type/secure)

## 590c. Medical gas covers

**Security Headwalls w/ 3/8" polycarbonate locked cover bottom hinge**

Modular Services Company

500 East Britton Road

Oklahoma City, OK 73114

800-687-0938

[www.heaswalls.com](http://www.heaswalls.com)

## 599a. Drinking water cup filling stations

**B103-C2-HR Water Bottle Filling Station Cup Dispenser and Disposal with security features**

Filtrine Manufacturing Company

15 Kit Street,

Keene, NH 03431

800-930-3367

[www.filtrine.com](http://www.filtrine.com)

Product information included in this document is intended for illustration of one or more specific items that are deemed appropriate for use in this type of facility. Comparable products by other manufacturers that meet the same design criteria may be substituted after careful comparison.

## 599b. Drinking water cup filling stations

**Quench 755 Countertop Filtered Water Cooler with UV**

Quench  
 780 5th Avenue, Suite 200  
 King of Prussia, PA 19406  
 888-877-0561  
[www.quenchonline.com](http://www.quenchonline.com)



## 600a. Air grilles

**Stamped, Perforated Diffuser; see catalog D-22**

Carnes® Company  
 448 South Main Street  
 Verona, WI 53593  
 608-845-6411  
[www.carnes.com](http://www.carnes.com)

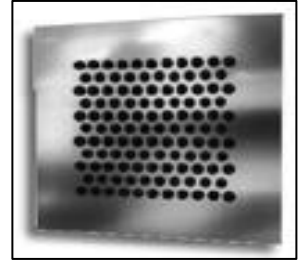

## 600b. Air grilles

**SEG-4P3 Security Grille – supply or return**

Kees Incorporated  
 400 S. Industrial Drive, PO Box 327  
 Elkhart Lake, WI 53020-0327  
 920-876-3391  
[www.kees.com](http://www.kees.com)

## 602a. Air grilles

**RRMX Extra Heavy Duty Grille with Removable Steel Perforated Face Plate**

Anemostat® Air Distribution  
 1220 Watson Center Road  
 Carson, CA. 90745  
 310-835-7500  
[www.anemostat.com](http://www.anemostat.com)

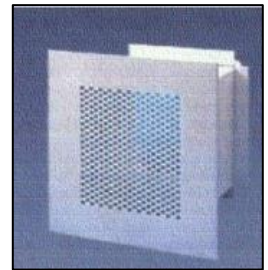

## 602b. Air grille

**814-R17 SR™ V-Vent High Security Grille**

Weizel Security  
 800-308-3627  
[www.securingshospitals.com](http://www.securingshospitals.com)

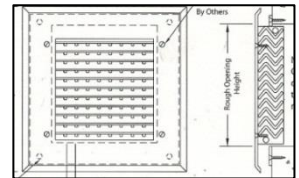

Product information included in this document is intended for illustration of one or more specific items that are deemed appropriate for use in this type of facility. Comparable products by other manufacturers that meet the same design criteria may be substituted after careful comparison.



604. Air grille – max security

***SG-SD Maximum Security Suicide Deterrent Grille, steel with 3/16-inch holes***

Titus

605 Shiloh Road

Plano, TX 75074

972-212-4800

[www.titus-hvac.com](http://www.titus-hvac.com)

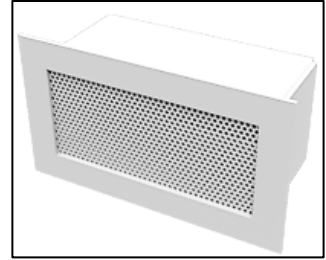

606. Fan coil enclosures

***Fan Coil Covers - Security***

ARSCO Manufacturing Company

5313 Robert Avenue

Cincinnati, OH 45248

800-543-7040

[www.arscomfg.com](http://www.arscomfg.com)



607. Thermostat – tamper-resistant

***KTP Series Stainless Steel Flush-Mount Thermistor***

Kele, Inc.

3300 Brother Blvd.

Bartlett, TN 38133

877-826-9045

[www.kele.com](http://www.kele.com)

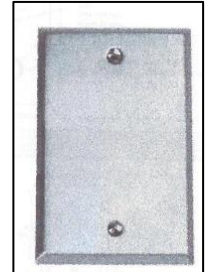

610a. Hospital-grade receptacles

***Hospital Grade GFCI Receptacles***

Hubbell Incorporated

Wiring Device-Kellems

40 Waterview Drive

Shelton, CT 06484

800-288-6000

[www.hubbell-wiring.com](http://www.hubbell-wiring.com)



Product information included in this document is intended for illustration of one or more specific items that are deemed appropriate for use in this type of facility. Comparable products by other manufacturers that meet the same design criteria may be substituted after careful comparison.

## 610b. Hospital-grade receptacles

**Hospital Grade GFCI Receptacles**

Cooper Industries  
 PO Box 4446  
 Houston, TX 77210-4446  
 713-209-8400

[www.cooperindustries.com](http://www.cooperindustries.com)

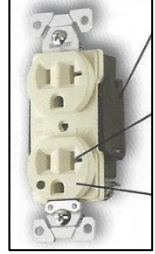

## 611a. Key-operated electric switches

**Pass & Seymour Locking Keyed Switch**

Legrand North America, LLC  
<http://www.legrand.us/passandseymour.aspx>



## 611b. Key-operated electric switches

**Leviton 1221-2KL Key Locking Extra Heavy Duty Switch**

Leviton Manufacturing Co., Inc.  
[www.leviton.com](http://www.leviton.com)



## 612c. Polycarbonate electrical coverplates

**Tiger Plates**

Cortech® USA  
 7530 Plaza Court  
 Willowbrook, IL 60527  
 800-571-0700

[www.cortechusa.com](http://www.cortechusa.com)

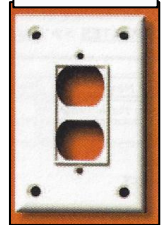

## 620a. Light fixture

**NASL-RND LED 2' diameter w/ flat polycarbonate lens and tamper resistant screws**

Day-O-Lite  
 126 Chestnut Street  
 Warwick, RI 02888  
 401-467-8232

[www.dayolite.com](http://www.dayolite.com)

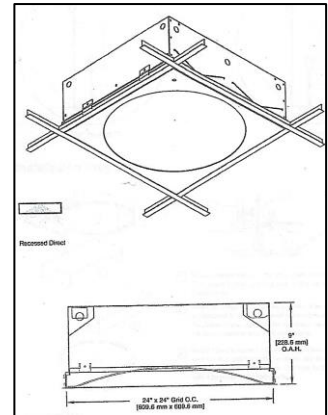

Product information included in this document is intended for illustration of one or more specific items that are deemed appropriate for use in this type of facility. Comparable products by other manufacturers that meet the same design criteria may be substituted after careful comparison.

## 620b. Light fixture

**Fino® ceiling mount and wall mount light fixtures**

Amerlux®, LLC  
 178 Bauer Drive  
 Oakland, NJ 07436  
 973-882-5010  
[www.amerlux.com](http://www.amerlux.com)



## 620c. Light fixture

**Fail-Safe SGI recessed, sealed, and gasketed with polycarbonate lens**

Eaton's Cooper Lighting  
 1121 Highway 74 South  
 Peachtree City, GA 30269  
 770-486-4800  
[www.cooperindustries.com](http://www.cooperindustries.com)



## 620d. Light fixture

**818-R13 SR™ Recessed Ceiling Lighting with polycarbonate lens**

Weizel Security  
 800-308-3627  
[www.securingshospitals.com](http://www.securingshospitals.com)

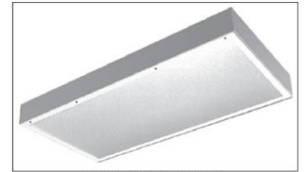

## 620e. Light fixture

**Mighty Mac WCBU Two-Aperture Bull Nose series**

Kenall®  
 10200 55th Street  
 Kenosha, WI 53144  
 800-453-6255  
[www.kenall.com](http://www.kenall.com)

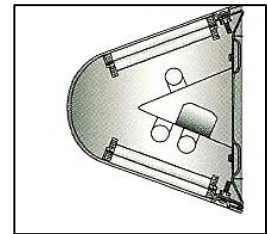

## 620f. Light fixture

**RDL/RHL Wet Label Downlight**

Designplan  
 79 Trenton Avenue  
 Frenchtown, NJ 08825  
 908-996-7710  
[www.designplan.com](http://www.designplan.com)



Product information included in this document is intended for illustration of one or more specific items that are deemed appropriate for use in this type of facility. Comparable products by other manufacturers that meet the same design criteria may be substituted after careful comparison.

620g. Light fixture

**Sonar 12 SPC12 Vandal Resistant wall mount fixture**

Luminaire Lighting Corporation  
5 Sutton Place  
P. O. Box 2162  
Edison, NJ 08818  
732-549-0056  
[www.luminairelighting.com](http://www.luminairelighting.com)

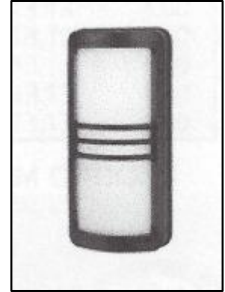

620h. Light fixture

**Anyx-13 ARV-13 Vandal Resistant round wall/ceiling mount fixture**

Luminaire Lighting Corporation  
5 Sutton Place  
P. O. Box 2162  
Edison, NJ 08818  
732-549-0056  
[www.luminairelighting.com](http://www.luminairelighting.com)



620i. Light fixture

**CRN Series with clear polycarbonate external lens and TP door fasteners**

The L.C. Doane Company  
P.O. Box 700  
Ivoryton, CT. 06442  
860-767-8295  
[www.lcdoane.com](http://www.lcdoane.com)

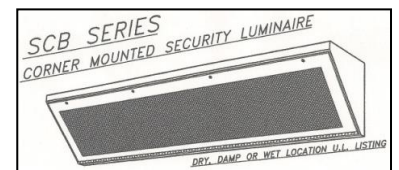
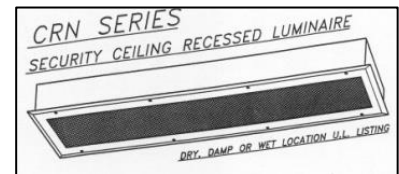

624. Polycarbonate prismatic lens

**CRN Series with prismatic polycarbonate lens**

The L.C. Doane Company  
P.O. Box 700  
Ivoryton, CT. 06442  
860-767-8295  
[www.lcdoane.com](http://www.lcdoane.com)

Product information included in this document is intended for illustration of one or more specific items that are deemed appropriate for use in this type of facility. Comparable products by other manufacturers that meet the same design criteria may be substituted after careful comparison.

## 630. Downlight cover

**Recesso Lights**

Recesso Lighting by Dolan Designs

13501 100th Avenue NE, #524

Kirkland, WA 98034

877-357-6127

<http://recessolighting.com>



## 637. Exterior lighting

**Exterior Vandal Resistant Lighting**

The Kirlin Company

3401 East Jefferson Avenue

Detroit, MI 48207

313-259-6400

[www.kirlinlighting.com](http://www.kirlinlighting.com)

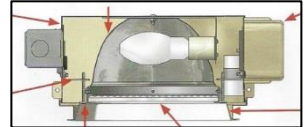

## 639. Night-light

**CM-25500 PathMaster Die Cast Mini LED Step Light**

Philips Lighting North America Corporation

(Chloride)

200 Franklin Square Drive

Somerset, NJ 08873

855-486-2216

[www.lightingproducts.philips.com](http://www.lightingproducts.philips.com)

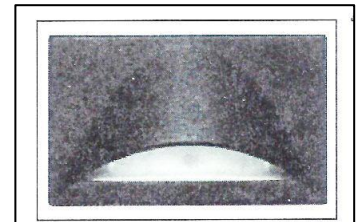

## 640a. Exit signs, LED – vandal-resistant

**Commercial Exist Signs SC Series – Cast Aluminum LED with vandal-resistant lens and tamperproof hardware**

Philips Lighting North America Corporation (Chloride)

200 Franklin Square Drive

Somerset, NJ 08873

855-486-2216

[www.lightingproducts.philips.com](http://www.lightingproducts.philips.com)



## 640b. Exit signs, lighted – vandal-resistant

**Mighty Mac MMEX Surface, Wall, or Ceiling Mount****Single/Double Face Exit w/ full-length mounting canopy**

Kenall®

10200 55th Street

Kenosha, WI 53144

800-453-6255

[www.kenall.com](http://www.kenall.com)

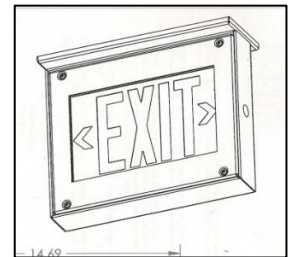

Product information included in this document is intended for illustration of one or more specific items that are deemed appropriate for use in this type of facility. Comparable products by other manufacturers that meet the same design criteria may be substituted after careful comparison.

642. Exit signs - photoluminescent

**EX424246-100G Ecoglo® Photoluminescent Exit Sign**

Access Products Inc.  
241 Main Street, Suite 100  
Buffalo, NY 14203  
888-679-4022  
[www.us.ecoglo.com](http://www.us.ecoglo.com)

650a. Wireless duress alarm

**INSTANTalarm® 5000**

Pinpoint®, Inc.  
2100 Southbridge Parkway, Suite 650  
Birmingham, AL 35209  
205-414-7541  
[www.pinpointinc.com](http://www.pinpointinc.com)

650f. Wireless duress alarm

**B3000n Communication Badge**

Vocera®  
525 Race Street  
San Jose, CA 95126  
888-986-2372  
[www.vocera.com](http://www.vocera.com)



653. Nurse call system – vandal-resistant

**HSS401 Responder Health Care Communications System High Security Staff Duty Station**

Rauland-Borg Corporation  
1802 West Central Road  
Mount Prospect, IL 60056  
800-752-7725  
[www.rauland.com](http://www.rauland.com)

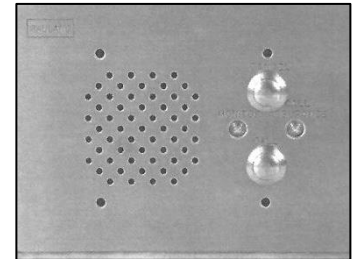

654. Pushbutton switch – vandal-resistant

**PV1-PV8 Anti-Vandal Switches**

Lamb Industries  
7153 Northland Drive  
Minneapolis, MN 55428  
800-867-2717  
<http://www.e-switch.com/>

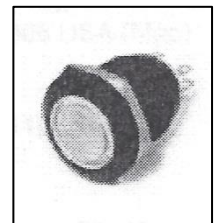

Product information included in this document is intended for illustration of one or more specific items that are deemed appropriate for use in this type of facility. Comparable products by other manufacturers that meet the same design criteria may be substituted after careful comparison.



## 655a. Stainless steel wall phones

**GB306V-14 Vandal-Resistant Telephone with 14" armored cord**

Allen Tel Products, Inc.  
 30 TVS Drive  
 Henderson, NV 89014  
 702-855-5700  
[www.allentel.com](http://www.allentel.com)



## 655b. Stainless steel wall phones

**SSW-321-X Ceeco Stainless Steel Wall Phone**

TWAcomm.com  
 8700 Warner Avenue, Suite 120  
 Fountain Valley, CA 92708  
 877-389-0000  
[www.twacomm.com](http://www.twacomm.com)



## 655c. Stainless steel wall phones

**CS400 Armored Courtesy Phone**

G-Tel Enterprises, Inc.  
 16840 Clay Road, #118  
 Houston, TX 77084  
 800-884-4835  
[www.payphone.com](http://www.payphone.com)



## 660. Outdoor furniture

**Hilltop Outdoor Furniture**

Norix Group, Inc.  
 1800 W. Hawthorne Lane, Suite N  
 West Chicago, IL 60185  
 800-234-4900  
[www.norix.com](http://www.norix.com)



Product information included in this document is intended for illustration of one or more specific items that are deemed appropriate for use in this type of facility. Comparable products by other manufacturers that meet the same design criteria may be substituted after careful comparison.

## 675a. Security fencing

**Mini-Mesh chain-link fencing**

Fence Factory  
29149 Agoura Road  
Agoura Hills, CA 91301  
800-613-3623  
[www.fencefactory.com](http://www.fencefactory.com)



## 675b. Security fencing

**WireWall® High Security Fencing - Maximum Security**

Riverdale Mills Corporation  
130 Riverdale Street; PO Box 920  
Northbridge, MA 01534  
800-762-6374  
[www.riverdale.com](http://www.riverdale.com)



## 675c. Security fencing

**Steel fence systems**

METALCO Fence & Railing Systems, Inc.  
3050 Sirius Ave, Suite 104  
Las Vegas, NV 89102  
800-708-2526  
[fence-system.com](http://fence-system.com)



## 675d. Security fencing

**Fortress Fencing**

Britplas  
18 Kingsland Grange  
Woolston  
Warrington, Cheshire, England WA1 4RW  
+44(01)-1925-824317  
[www.britplas.com](http://www.britplas.com)



Product information included in this document is intended for illustration of one or more specific items that are deemed appropriate for use in this type of facility. Comparable products by other manufacturers that meet the same design criteria may be substituted after careful comparison.

## ABOUT THE AUTHORS

**James M. Hunt, AIA**, is a practicing architect and facility management professional with more than 40 years of experience. He is a registered architect and began his career practicing architecture for several major health care projects. He then served as director of facility management for the Menninger Clinic for 20 years. In addition to managing the clinic's main campus, he consulted on behavioral health care unit remodeling projects for their Clinical Network program in eight states. During this time, Mr. Hunt was a founding member of the Health Care Council of the International Facility Management Association. He held several offices in the council, including chair. He publishes articles and speaks at major conferences frequently. He is president of Behavioral Health Facility Consulting, LLC (BHFC), an organization that consults with behavioral health organizations and architects who design behavioral health facilities regarding their unique requirements for patient and staff safety. He has worked with behavioral health facilities in more than 30 states and Canada. He can be reached at [jim@bhfccllc.com](mailto:jim@bhfccllc.com).

**David M. Sine, DrBE, CSP, ARM, CPHRM**, has had a career of more than 25 years in safety, risk management, human factors, and organizational consulting. He has been state safety director of two eastern states, senior staff engineer for the Joint Commission, and a senior consultant for the American Hospital Association. Founding partner and one-time contributing editor for *Briefings on Hospital Safety*, co-author of *Quality Improvement Techniques for Hospital Safety*, and one-time vice chair of the board of Brackenridge Hospital in Austin, Texas, Mr. Sine is certified by the Joint Board of the American Board of Industrial Hygiene and Certified Safety Professionals and as a Certified Professional Healthcare Risk Manager by ASHRM. He has been a health care risk management consultant since 1980 and has conducted more than 1,300 Joint Commission compliance assessment surveys. He serves as a member of the NFPA 101 Life Safety Code Subcommittee on Health Care Occupancies, the Joint Commission Committee on Healthcare Safety, and the FGI Health Guidelines Revision Committee and acts as a risk management adviser to the National Association of Psychiatric Health Systems. He served in the corporate offices of the Tenet HealthSystem in Dallas as director of risk assessment and loss prevention and vice president of occupational health and safety. Mr. Sine continues to write and lecture extensively on health care policy, governance, quality improvement, and risk management as President of SafetyLogic Systems. He can be reached at [dsine9@gmail.com](mailto:dsine9@gmail.com).

Product information included in this document is intended for illustration of one or more specific items that are deemed appropriate for use in this type of facility. Comparable products by other manufacturers that meet the same design criteria may be substituted after careful comparison.

## DEFINITIONS / RESOURCES

***Americans with Disabilities Act (ADA)***. The *Americans with Disabilities Act* gives civil rights protections to individuals with disabilities similar to those provided to individuals on the basis of race, color, sex, national origin, age, and religion. It guarantees equal opportunity for individuals with disabilities in public accommodations, employment, transportation, state and local government services, and telecommunications. See [www.ada.gov/](http://www.ada.gov/).

***Guidelines for Design and Construction of Hospitals and Outpatient Facilities – 2014 edition***. This book, published by the Facility Guidelines Institute, includes chapters on psychiatric hospitals and outpatient psychiatric centers. For information on purchasing the FGI *Guidelines*, visit [www.fgiguideines.org](http://www.fgiguideines.org).

***Health Insurance Portability and Accountability Act of 1996 (HIPAA)***. The Office for Civil Rights in the U.S. Department of Health and Human Services (HHS) enforces the HIPAA Privacy Rule, which protects the privacy of individually identifiable health information; the HIPAA Security Rule, which sets national standards for the security of electronic protected health information; and the confidentiality provisions of the Patient Safety Rule, which protect identifiable information being used to analyze patient safety events and improve patient safety. See [www.hhs.gov/ocr/privacy](http://www.hhs.gov/ocr/privacy).

**The Joint Commission**. See [www.jointcommission.org](http://www.jointcommission.org) for their standards.

**National Fire Protection Association (NFPA)**. The NFPA publishes NFPA 101: *Life Safety Code*®, which is available at [http://www.nfpa.org/catalog/product.asp?pid=10109&order\\_src=A291](http://www.nfpa.org/catalog/product.asp?pid=10109&order_src=A291). For more on NFPA or links to new publications, see [www.NFPA.org](http://www.NFPA.org).

**National Institute of Corrections**. See [www.nicic.gov](http://www.nicic.gov).

Product information included in this document is intended for illustration of one or more specific items that are deemed appropriate for use in this type of facility. Comparable products by other manufacturers that meet the same design criteria may be substituted after careful comparison.

## LIST OF MANUFACTURERS

Access Products, [www.us.ecoglo.com](http://www.us.ecoglo.com)  
Accurate, [www accuratelockandhardware.com](http://www accuratelockandhardware.com)  
Ace Security, [www.smashandgrab.com](http://www.smashandgrab.com)  
Acorn Engineering Co., [www.acorneng.com](http://www.acorneng.com)  
Allen Tel Products, [www.allentel.com](http://www.allentel.com)  
Alro Plastics, [www.alro.com](http://www.alro.com)  
American Innovation, [www.americaninnovationproducts.com](http://www.americaninnovationproducts.com)  
American Specialties, [www.americanspecialties.com](http://www.americanspecialties.com)  
American Standard, [www.americanstandard-us.com/](http://www.americanstandard-us.com/)  
Anemostat, [www.anemostat-hvac.com](http://www.anemostat-hvac.com)  
Archer Manufacturing, [www.vandalproof.org](http://www.vandalproof.org)  
Armstrong Flooring, [www.armstrong.com](http://www.armstrong.com)  
Armstrong International, <http://armstronginternational.com>  
Arso, [www.arscomfg.com](http://www.arscomfg.com)  
Avonite, [www.avonitesurfaces.com](http://www.avonitesurfaces.com)  
BASF, [www.master-builders-solutions.basf.us](http://www.master-builders-solutions.basf.us)  
Behavioral Safety Products, [www.besafepro.com](http://www.besafepro.com)  
Best Access Solutions, Inc., <http://www.bestaccess.com/index.php/products/behavioral-health-products/>  
Bath, [www.best-bath.com](http://www.best-bath.com)  
Big John, [www.bigjohntoiletseat.com](http://www.bigjohntoiletseat.com)  
Blockhouse, [www.blockhouse.com](http://www.blockhouse.com)  
Bradley, [www.bradleycorp.com](http://www.bradleycorp.com)  
Brey-Krause, [www.breykrause.com](http://www.breykrause.com)  
Britplas, [www.britplas.com](http://www.britplas.com)  
Carnes, [www.carnes.com](http://www.carnes.com)  
Carstens, [www.carstens.com](http://www.carstens.com)  
Cascade, [www.cascadesh.com](http://www.cascadesh.com)  
Ceco, [www.cecodoor.com](http://www.cecodoor.com)  
CHG, [www.chgbeds.com](http://www.chgbeds.com)  
Chloride, [www.chloridesys.com/chloride](http://www.chloridesys.com/chloride)  
CompX, [www.compx.com](http://www.compx.com)  
Comfortex, [www.comfortex.com](http://www.comfortex.com)  
Cooper, [www.cooperindustries.com](http://www.cooperindustries.com)  
Cortech, [www.cortechusa.com](http://www.cortechusa.com)  
CS Acrovyn, [www.c-sgroup.com](http://www.c-sgroup.com)  
Curries, [www.curries.com](http://www.curries.com)  
Custom Design Frameworks, [www.customdesignframeworks.com](http://www.customdesignframeworks.com)  
Dano Group, <http://www.danogroup.com>  
Designplan, [www.designplan.com](http://www.designplan.com)  
Dex-O-Tex, [www.dexotex.com](http://www.dexotex.com)  
DHSl, [www.dhsl-seal.com](http://www.dhsl-seal.com)  
Door Control Services, [www.doorcontrolsusa.com](http://www.doorcontrolsusa.com)  
Door Switch, <http://thedoorswitch.com>

Product information included in this document is intended for illustration of one or more specific items that are deemed appropriate for use in this type of facility. Comparable products by other manufacturers that meet the same design criteria may be substituted after careful comparison.

Draper, Inc., [www.draperinc.com](http://www.draperinc.com)  
Dur-A-Flex, [www.dur-a-flex.com](http://www.dur-a-flex.com)  
Dynalock Corp, [www.dynalock.com](http://www.dynalock.com)  
Eggrock, [www.eggrock.com](http://www.eggrock.com)  
Fence Factory, [www.fencefactory.com](http://www.fencefactory.com)  
Filtrine Manufacturing Co.; [www.filtrine.com](http://www.filtrine.com)  
Flexco, [www.flexcofloors.com/](http://www.flexcofloors.com/)  
Flxsigns, [www.290signs.com](http://www.290signs.com)  
G-Tel, [www.payphone.com/](http://www.payphone.com/)  
Global, [www.security-qlazing.com](http://www.security-qlazing.com)  
GoJo Industries, [www.GOJO.com](http://www.GOJO.com)  
Graham Wood Doors, [www.grahamdoors.com](http://www.grahamdoors.com)  
Grainger, [www.grainger.com](http://www.grainger.com)  
Hafele, [www.hafele.com/us/index.htm](http://www.hafele.com/us/index.htm)  
Hager Companies, [www.hagerco.com](http://www.hagerco.com)  
Hospital Systems Inc., [www.HospitalSystems.com](http://www.HospitalSystems.com)  
Hubbell, [www.hubbell-wiring.com](http://www.hubbell-wiring.com)  
IE; Blinds, [www.ieblinds.com](http://www.ieblinds.com)  
Intersan, [www.intersan.us](http://www.intersan.us)  
Ives, <http://us.allegion.com/>  
J. L. Industries, [www.jlindustries.com](http://www.jlindustries.com)  
Johnsonite, [www.roppe.com](http://www.roppe.com)  
Kane Mfg., [www.kanescreens.com](http://www.kanescreens.com)  
Kawneer Company, Inc., [www.kawneer.com](http://www.kawneer.com)  
Kees, [www.kees.com](http://www.kees.com)  
Kele, Inc., [www.kele.com](http://www.kele.com)  
Kenall, [www.kenall.com](http://www.kenall.com)  
Kennon Products, [www.suicideproofing.com](http://www.suicideproofing.com)  
King Architectural Products, [www.kingarchitecturalproducts.com](http://www.kingarchitecturalproducts.com)  
Kingsway Group USA [www.kingswaygroupusa.com](http://www.kingswaygroupusa.com)  
Kirlin, [www.kirlinlighting.com](http://www.kirlinlighting.com)  
Kwalu, [www.kwalu.com](http://www.kwalu.com)  
L. C. Doane, [www.lcdoane.com](http://www.lcdoane.com)  
LCN, <http://us.allegion.com/brands/lcn/Pages/default.aspx>  
Lamb Industries, [www.e-switch.com](http://www.e-switch.com)  
Lee's Carpet, [www.leescarpets.com](http://www.leescarpets.com)  
Lonseal, <http://lonseal.com>  
Luminaire, [www.luminairelighting.com](http://www.luminairelighting.com)  
Manko Windows, [www.mankowindows.com](http://www.mankowindows.com)  
Maiman, [www.maiman.com](http://www.maiman.com)  
Marathon, [www.flexcofloors.com](http://www.flexcofloors.com)  
Markar,  
<https://www.assaabloydooraccessories.us/en/local/assaabloydooraccessoriesus/products/hinges/continuous-pin-barrel-hinges/behavioral-health-hinges/>

Product information included in this document is intended for illustration of one or more specific items that are deemed appropriate for use in this type of facility. Comparable products by other manufacturers that meet the same design criteria may be substituted after careful comparison.



Marks USA, [www.marksusa.com](http://www.marksusa.com)  
Marshfield Door Systems, [www.marshfielddoors.com](http://www.marshfielddoors.com)  
McMaster-Carr, [www.mcmaster.com](http://www.mcmaster.com)  
Metalco, [www.fence-system.com](http://www.fence-system.com)  
Mockett, Doug, [www.mockett.com](http://www.mockett.com)  
Moduform, [www.moduform.com](http://www.moduform.com)  
Modular Services, <http://headwalls.com>  
National Gypsum, [www.nationalgypsum.com](http://www.nationalgypsum.com)  
Nemschoff, [www.nemschoff.com](http://www.nemschoff.com)  
Nora Systems, Inc.; [www.nora.com/us](http://www.nora.com/us)  
Norix, [www.norix.com](http://www.norix.com)  
Northwest Specialty Hardware. [www.northwestsh.com](http://www.northwestsh.com)  
Norva Plastics, [www.norvaplastics.com](http://www.norvaplastics.com)  
Odd Ball, [www.oddballindustries.com](http://www.oddballindustries.com)  
O'Keeffe's, Inc., [www.safti.com](http://www.safti.com)  
Oldcastle, [www.oldcastlebe.com](http://www.oldcastlebe.com)  
Pabco Gypsum, [www.quietrock.com](http://www.quietrock.com)  
Padded Surfaces, [paddedsurfaces.com/CAD.html](http://paddedsurfaces.com/CAD.html)  
Pecora, [www.pecora.com](http://www.pecora.com)  
Peerless A-V, [www.perlessmounts.com](http://www.perlessmounts.com)  
Pinpoint, [www.pinpointinc.com](http://www.pinpointinc.com)  
Quench; [www.quenconline.com](http://www.quenconline.com)  
Quick Drain USA, [www.quickdrain.com](http://www.quickdrain.com)  
RAL & Associates, [www.ieblinds.com](http://www.ieblinds.com)  
Rauland - Borg Corp., [www.rauland.com](http://www.rauland.com)  
Re\*cesso Lights, <http://recesslighting.com/>  
Riverdale Mills, [www.wirewall.com](http://www.wirewall.com)  
ROA Contract Sales, [www.rao.com](http://www.rao.com)  
Rockwood, [www.rockwoodmfg.com](http://www.rockwoodmfg.com)  
Roppe, [www.roppe.com](http://www.roppe.com)  
Sabic, [www.sabic.com](http://www.sabic.com)  
SaftiFirst (O'Keeffe's, Inc.), [www.safti.com](http://www.safti.com)  
Sani-liner, [www.wisconsinconverting.com](http://www.wisconsinconverting.com)  
Sargent Lock, [www.sargentlock.com](http://www.sargentlock.com)  
Schlage, <http://us.allegion.com>  
Scotchshield, <http://solutions.3m.com/>  
Securitech Group, Inc., [www.securitech.com](http://www.securitech.com)  
Sheffield, [www.sheffieldplastics.com](http://www.sheffieldplastics.com)  
Sherwood Windows Group, [www.sherwoodwindows.com](http://www.sherwoodwindows.com)  
Sizewise, [www.sizewise.net](http://www.sizewise.net)  
Sloan, [www.sloanvalve.com](http://www.sloanvalve.com)  
Spec, [www.specfurniture.com](http://www.specfurniture.com)  
Stanley Hardware, [www.stanleyhardware.com](http://www.stanleyhardware.com)  
Stanley Security, [www.stanleysecuritysolutions.com](http://www.stanleysecuritysolutions.com)  
Sto Americas, [www.stocorp.com](http://www.stocorp.com)

Product information included in this document is intended for illustration of one or more specific items that are deemed appropriate for use in this type of facility. Comparable products by other manufacturers that meet the same design criteria may be substituted after careful comparison.

Stryker, [/www.stryker.com/en-us/products/PatientHandlingEMSandEvacuationEquipment/index.htm](http://www.stryker.com/en-us/products/PatientHandlingEMSandEvacuationEquipment/index.htm)  
Sugatsune, [www.sugatsune.com](http://www.sugatsune.com)  
Surebond, [www.surebond.com](http://www.surebond.com)  
Tamperproof Screws, [www.tamperproof.com](http://www.tamperproof.com)  
This End Up, [www.thisendup.com](http://www.thisendup.com)  
3M, [www.3m.com](http://www.3m.com)  
Titus, [www.titus-hvac.com](http://www.titus-hvac.com)  
Top Knobs, [www.myknobs.com](http://www.myknobs.com)  
Total Door, [www.total-door.com](http://www.total-door.com)  
Total Lock and Security, [www.totallock.com](http://www.totallock.com)  
Townsteel, [www.townsteel.com](http://www.townsteel.com)  
Truebro, [www.truebro.com/plumbing/truebro/lavshield](http://www.truebro.com/plumbing/truebro/lavshield)  
Truth Hdw., [www.truth.com](http://www.truth.com)  
TWA Comm, [www.twacomm.com](http://www.twacomm.com)  
2/90 Sign Systems, [www.290signs.com](http://www.290signs.com)  
Tyco, [www.tyco-fire.com](http://www.tyco-fire.com)  
Unicel, [www.unicelarchitectural.com/en/index.php](http://www.unicelarchitectural.com/en/index.php)  
USG Sheetrock, [www.usg.com/content/usgcom/en.html](http://www.usg.com/content/usgcom/en.html)  
Vistamatic, [www.vistamaticvisionpanels.com/](http://www.vistamaticvisionpanels.com/)  
Vocera, [www.vocera.com](http://www.vocera.com)  
Wausau Windows, [www.wausauwindow.com](http://www.wausauwindow.com)  
Webb Shade, [www.webbshade.com](http://www.webbshade.com)  
Weizel Security, [www.securingshospitals.com](http://www.securingshospitals.com)  
Whitehall, [www.whitehallmfg.com](http://www.whitehallmfg.com)  
Willoughby Industries, [www.willoughby-ind.com](http://www.willoughby-ind.com)  
Zurn, [www.zurn.com](http://www.zurn.com)

Product information included in this document is intended for illustration of one or more specific items that are deemed appropriate for use in this type of facility. Comparable products by other manufacturers that meet the same design criteria may be substituted after careful comparison.